

Series 94

User's Manual



1/16 DIN Limit Controller



ISO 9001



Registered Company
Winona, Minnesota USA

1241 Bundy Blvd., P.O. Box 5580, Winona, Minnesota USA 55987-5580
Phone: (507) 454-5300, Fax: (507) 452-4507 <http://www.watlow.com>

NOTE:
Details of a “Note” appear here in the narrow margin on the outside of each page.

 **CAUTION:**
Details of a “Caution” appear here in the narrow margin on the outside of each page.

 **WARNING:**
Details of a “Warning” appear here in the narrow margin on the left side of each page.

Safety Information

We use note, caution and warning symbols throughout this book to draw your attention to important operational and safety information.

A bold text “NOTE” marks a short message in the margin to alert you to an important detail.

A bold text “CAUTION” safety alert appears with information that is important for protecting your equipment and performance. Be especially careful to read and follow all cautions that apply to your application.

A bold text “WARNING” safety alert appears with information that is important for protecting you, others and equipment from damage. Pay very close attention to all warnings that apply to your application.

The safety alert symbol, , (an exclamation point in a triangle) precedes a general CAUTION or WARNING statement.

The electrical hazard symbol, , (a lightning bolt in a triangle) precedes an electric shock hazard CAUTION or WARNING safety statement.

Technical Assistance

If you encounter a problem with your Watlow controller, review all of your configuration information for each step of the setup to verify that your selections are consistent with your applications.

If the problem persists after checking all the steps, you can get technical assistance by calling Watlow Controls at +1 (507) 494-5656, between 7 a.m. and 5 p.m. CST, and asking for an applications engineer. When you call, have the following information on hand: the controller’s model number (the 12-digit number is printed on the top of the stickers on each side of the controller’s case and on the right-hand or top circuit board); your user’s manual; and all configuration information.

Your Feedback

Your comments or suggestions on this manual are welcome, please send them to: Technical Writer, Watlow Winona, 1241 Bundy Boulevard, P.O. Box 5580, Winona, MN 55987-5580, Phone: +1 (507) 454-5300, Fax: +1 (507) 452-4507. The Series 94 User’s Manual is copyrighted by Watlow Winona, Inc., © June 2002, with all rights reserved. (2290)

Chapter 1: Overview	1.1	Figures	Page
General Description	1.1	Series 94 Input & Output Overview	1.1
Chapter 2: Install and Wire the Series 94	2.1	Multiple Panel Cutout Dimensions	2.1a
Panel Cutout	2.1	Series 94 Dimensions	2.1b
Dimensions	2.1	Mounting Case Side View	2.2a
Installation Procedure	2.1	Mounting Collar Cross Section	2.2b
Wiring the Series 94	2.3	Case Rear View & NEMA 4X Seal Example	2.2c
Sensor Installation Guidelines	2.4	Power Wiring	2.3
Input Wiring	2.4	Thermocouple Sensor Input Wiring	2.4a
Output 1 Wiring	2.5	2- or 3-wire RTD Sensor Input Wiring	2.4b
Output 2 Wiring	2.5	Output 1 Mechanical Relay Wiring	2.5a
System Wiring Example	2.7	Output 2 Mechanical Relay Wiring	2.5b
Chapter 3: How to Use the Keys and Displays	3.1	Output 2 Solid-state Relay w/o Suppression Wiring	2.6a
Keys, Displays & Indicator Lights	3.1	Output 2 Switched DC Wiring	2.6b
Chapter 4: How to Set Up the Series 94	4.1	System Wiring Example	2.7
Setting the Input Type DIP Switch	4.1	Wiring Notes	2.8
Entering Setup Menu	4.2	Series 94 Keys and Displays	3.1
Setup Parameters	4.3	DIP Switch Location & Orientation	4.1a
Setup Menu Table	4.5	Input DIP Switches	4.1b
Operation Parameters	4.6	Entering the Setup Menu	4.2a
Operation Menu Table	4.6	The Setup Menu	4.2b
Chapter 5: Alarms and Errors	5.1	The Operation Menu	4.6
Using Alarms	5.1	Clearing an Alarm	5.1
Error Code Messages	5.2	Error Code Message	5.2
Error Code Actions	5.2	Entering the Calibration Menu	A.3
Appendix	A.1	Calibration Menu	A.4
Decreasing Noise Sensitivity	A.1	Tables	Page
Eliminating Noise	A.2	Input Ranges	4.5a
Calibration	A.3	Setup Menu Prompts/Description	4.5b
Restoring Factory Calibration	A.4	Operation Menu Prompts/Description	4.6
Calibration Menu	A.4	Quick Reference Sheet	A.13-A.14
Calibration Procedures	A.5		
Glossary	A.7		
Specifications	A.9		
Model Number Information	A.10		
Index	A.11		
Declaration of Conformity	A.12		
Quick Reference	A.13		

Notes

1

Overview of the Series 94

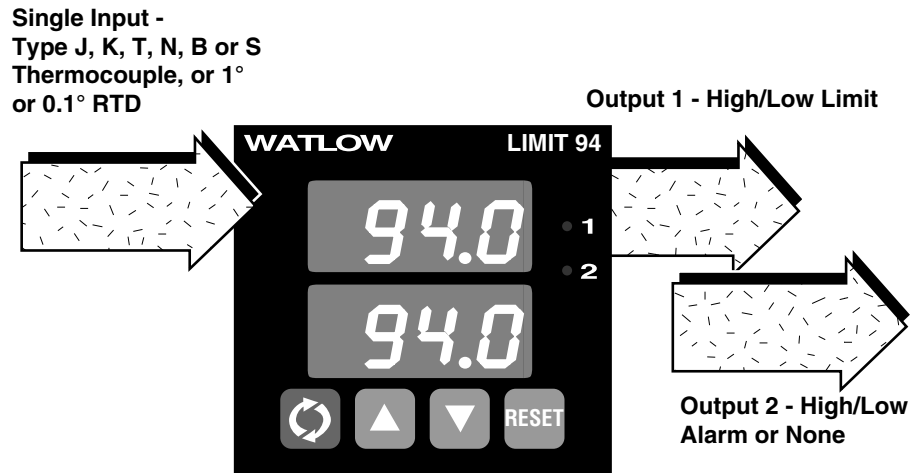

Figure 1.1 - Series 94 Input and Output Overview

General Description

Welcome to the Watlow Series 94, a 1/16 DIN microprocessor-based limit controller. The 94 has a single input that accepts a type B, J, K, T, N or S thermocouple or RTD input.

The Series 94 controller limits over-temperature conditions in thermal applications. The limit controller protects against high-temperature runaway conditions resulting from a shorted input sensor or a failed output device. A limit controller is recommended in any application where thermal runaway could affect operator safety, damage equipment or cause large product scrap costs.

The limit output is latching. An optional process alarm output can be configured as latching or non-latching, with high and low alarm set points.

Special 94 features include the optional NEMA 4X rating, dual four-digit displays in either red or green and optional low-voltage power supply.

Operator-friendly features include automatic LED indicators to aid in monitoring and setup, as well as a calibration offset at the front panel. The Watlow Series 94 automatically stores all information in a non-volatile memory.

Notes

2

Install and Wire the Series 94

NOTE:

For rapid mounting, use Greenlee 1/16 DIN punch, die, draw stud, part number 60287.

NOTE:

Measurements between panel cutouts are the minimum recommended.

Figure 2.1a - Series 94 Multiple Panel Cutout Dimensions.

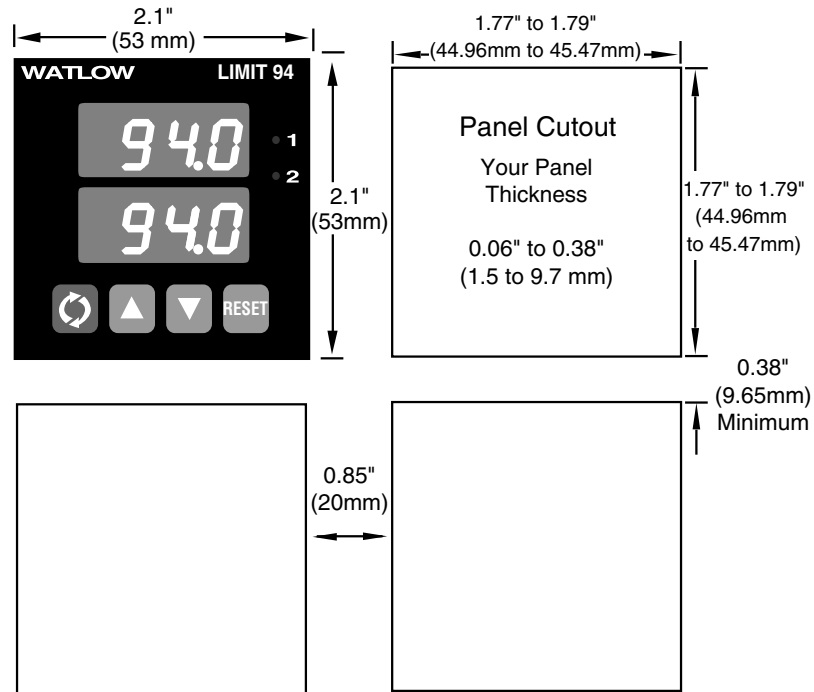
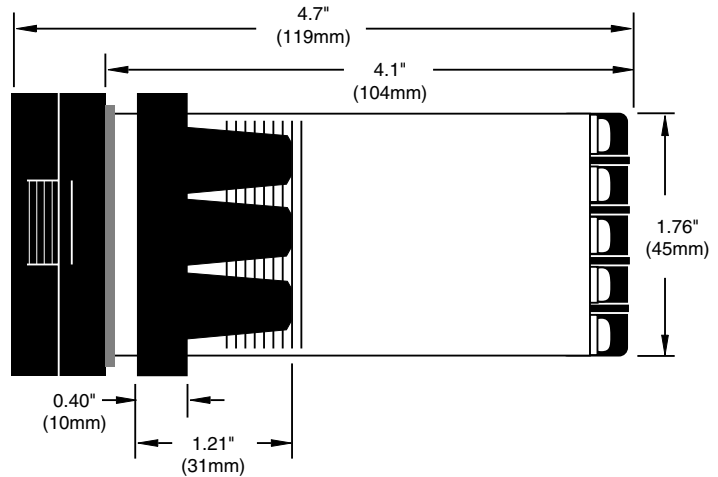

Figure 2.1b- Series 94 Dimensions.



Installation Procedure

Bold print denotes requirement for NEMA 4X seal. Follow this procedure to mount the Watlow Series 94 temperature control:

1. Make a panel cutout using the dimensions in Figure 1a.
2. **If your controller model number begins with 94B, make sure the rounded side of the external case gasket is facing the panel surface.** Check to see that the gasket is not twisted, and is seated within the case bezel flush with the panel. Place the case in the cutout. Make sure the gasket is between the panel cutout and the case bezel.

**Figure 2.2a -
Mounting Case Side
View.**

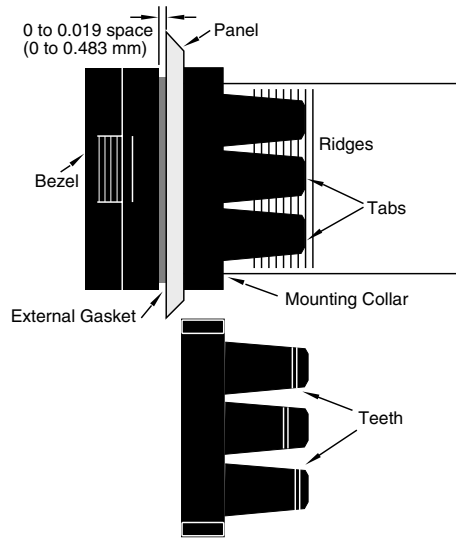

**Figure 2.2b -
Mounting Collar
Cross Section with
offset teeth.**

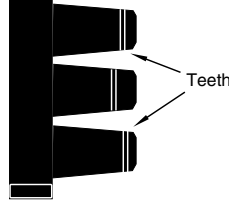

3. While pressing the front of the case firmly against the panel, slide the mounting collar over the back of the control. The tabs on the collar must line up with the mounting ridges on the case for secure installation. See Figure 2 a. Slide the collar firmly against the back of the panel getting it as tight as possible.

To ensure a tight seal, use your thumb to lock the tabs into place while pressing the case from side to side. Don't be afraid to apply enough pressure to install the control. The tabs on each side of the collar have teeth which latch into the ridges. See Figure 2b. Each tooth is staggered at a different height, so only one of the tabs on each side are ever locked into the ridges at any time.

As depicted in Figure 2.2c, confirm that the tabs on one side of the collar correspond with those on the opposite side. Make sure the two corresponding tabs are the only ones locked in the ridges at the same time.

If the corresponding tabs are not supporting the case at the same time and the space between the panel and the case bezel is greater than .019", you will will not have a NEMA 4X seal. This applies to units with models designated 94B. However, all units should be mounted in this fashion to guarantee integrity of the mounting system.



CAUTION: Follow the installation procedure exactly to guarantee a proper NEMA 4X seal. Make sure the gasket between the panel and the rim of the case is not twisted and is seated properly. Failure to do so could result in damage to equipment.

**Figure 2.2c -
Case Rear View and
NEMA 4X Seal
Example.**

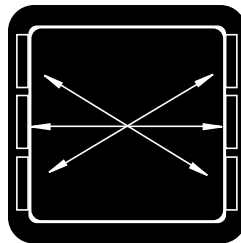

Make sure that the two corresponding tabs are locked in the ridges at the same time.

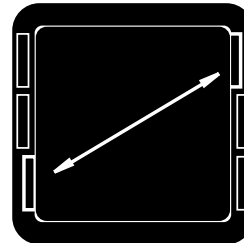

NEMA 4X Seal Example.

4. Insert the control chassis into its case and press the bezel to seat it. Make sure the inside gasket is also seated properly and not twisted. The hardware installation is complete. Proceed to the wiring section from here.

Removing the Series 94 Controller

When removing the mounting collar, we suggest using a thin tool such as a putty knife or screwdriver to pry gently under each of the six tabs to disengage the teeth. Then rock the collar back and forth until it can be easily pulled off the case.



WARNING: To avoid electric shock, use National Electric Code (NEC) safety practices when wiring and connecting this unit to a power source and to electrical sensors or peripheral devices. Failure to do so could result in injury or death.

NOTE:

Taking the unit out of the case is not a normal operating condition and should only be done by a qualified maintenance installation technician. Power to the case should be disconnected before removing or installing the controller into its case.



WARNING: The case terminals may still carry live voltage when the unit is removed.



WARNING: Irreversible damage will occur if high voltage is applied to the low voltage unit.

Wiring the Series 94

The Series 94 wiring is illustrated by model number option. Check the unit sticker on the controller and compare your model number to those shown here and also the model number breakdown in the Appendix of this manual.

All outputs are referenced to a de-energized state. The final wiring figure is a typical system example.

When you apply power without sensor inputs on the terminal strip, the Series 94 displays `---` in the upper display, and `Er7` in the lower display after 30 seconds on power-up. This error indicates an open sensor or A/D error. All wiring and fusing must conform to the National Electric Code and to any locally applicable codes as well.

Power Wiring

High Voltage

100 to 240~ (ac), nominal (85 to 264 actual) 94__-1__0-00__

Low Voltage

12-24V≈ (ac/dc) 94__-1__1-00__

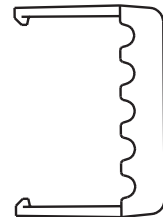
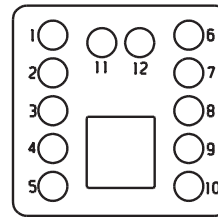
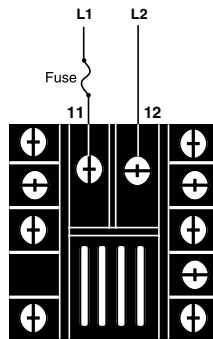
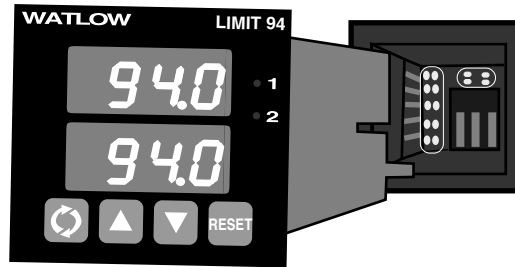

Figure 2.3 – Power wiring.

NOTE: Optional protective rear terminal cover, 0822-0426-P001, is available. Contact Watlow customer service or your local Watlow sales representative.



WARNING: To avoid electric shock and damage to property and equipment, use National Electric Code (NEC) safety practices when wiring and connecting this unit to a power source and to electrical sensors or peripheral devices. Failure to do so could result in injury or death.

Sensor Installation Guidelines

We suggest you mount the sensor at a location in your process or system where it reads an average temperature. Put the sensor as near as possible to the material or space you want to protect. Air flow past this sensor should be moderate. The sensor should be thermally insulated from the sensor mounting.

See Chapter 4 for more information on DIP switch location and orientation.

Input Wiring

Figure 2.4a – Thermocouple

Extension wire for thermocouples must be of the same alloy as the thermocouple itself to limit errors.

NOTE:

When an external device with a non-isolated circuit common is connected to the dc output, you must use an isolated or ungrounded thermocouple.

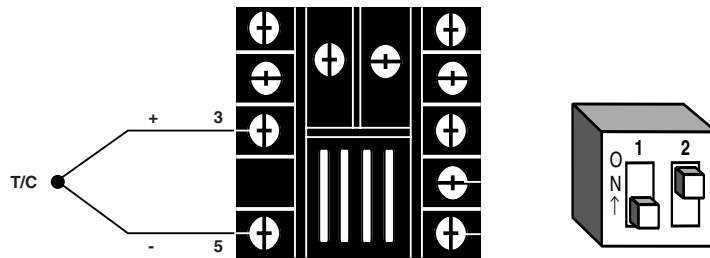

DIP Switch orientation

Figure 2.4b – RTD (2- or 3-Wire) 100Ω Platinum

There could be a + 2°F input error for every 1Ω of lead length resistance when using a 2-wire RTD. That resistance, when added to the RTD element resistance, will result in erroneous input to the instrument. To overcome this problem, use a 3-wire RTD sensor, which compensates for lead length resistance. When extension wire is used for a 3-wire RTD, all wires must have the same electrical resistance (i.e. same gauge, same length, multi-stranded or solid, same metal).

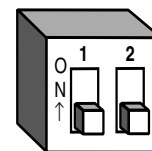
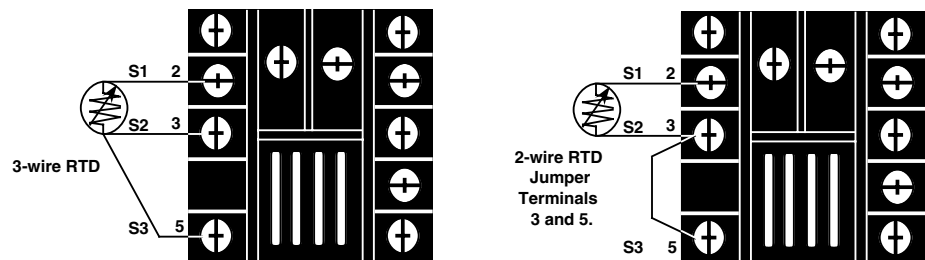

DIP Switch orientation

NOTE:

Successful installation requires four steps:

- Choose the controller's hardware configuration and model number (Appendix);
- Choose a sensor (Chapter Two and Appendix);
- Install and wire the controller (Chapter Two);
- Configure the controller (Chapters Three, Four and Five).

NOTE 1:

Switching inductive loads (relay coils, solenoids, etc.) with the mechanical relay, switched dc or solid-state relay output options requires use of an R.C. suppressor.

Watlow carries the R.C. suppressor **Quencharc** brand name, which is a trademark of ITW Paktron. Watlow Part No. 0804-0147-0000.



WARNING: To avoid damage to property and equipment, and/or injury or loss of life, use National Electric Code (NEC) standard wiring practices to install and operate the Series 94. Failure to do so could result in such damage, and/or injury or death.

Output 1 Wiring

Figure 2.5a – Mechanical Relay Without Contact Suppression

94__-1D__-00__

Form C, 5 amps

Minimum load current:

100 mA at 5V_{DC} (dc)

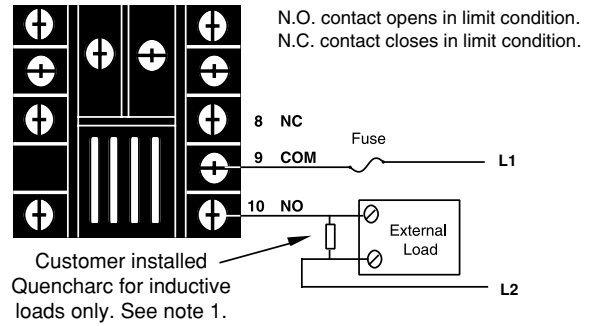

Output 2 Wiring

Figure 2.5b – Mechanical Relay Without Contact Suppression

94__-1D D - 00__

Form C, 5 Amp

Minimum load current:

100 mA at 5V_{DC} (dc)

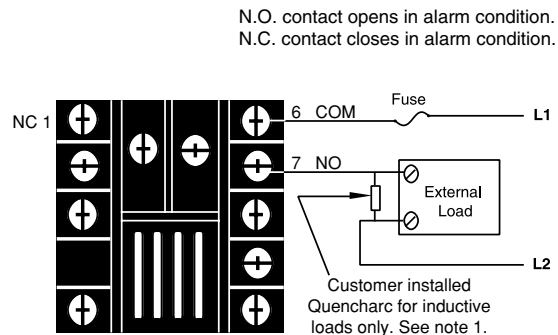

NOTE:

Output is in de-energized state in Alarm Condition.

NOTE 1:

Switching inductive loads (relay coils, solenoids, etc.) with the mechanical relay, solid-state relay output options requires use of an R.C. suppressor.

Watlow carries the R.C. suppressor Quencharc brand name, which is a trademark of ITW Paktron. Watlow Part No. 0804-0147-0000.

NOTE 2:

When an external device with a non-isolated circuit common is connected to the dc output, you must use an isolated or ungrounded thermocouple.



WARNING: To avoid damage to property and equipment, and/or injury or loss of life, use National Electric Code (NEC) standard wiring practices to install and operate the Series 94. Failure to do so could result in such damage, and/or injury or death.

Figure 2.6a – Solid-state Relay Without Contact Suppression

94__ - 1D K _ - 00__
 0.5 Amp (AC loads only)
 Form A

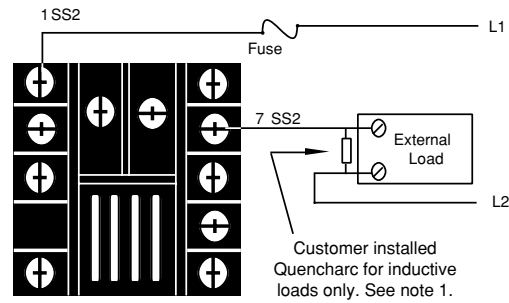
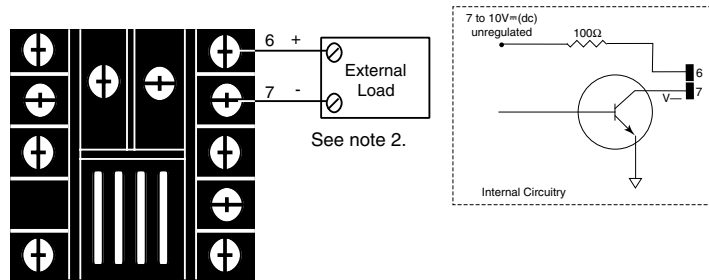

Figure 2.6b – Switched DC

94__ - 1D C _ - 00__



NOTE:

Successful installation requires four steps:

- Choose the controller's hardware configuration and model number (Appendix);
- Choose a sensor (Chapter Two and Appendix);
- Install and wire the controller (Chapter Two);
- Configure the controller (Chapters Three, Four and Five).

NOTE 3:

Output is in open state in Alarm Condition.

Wiring Example

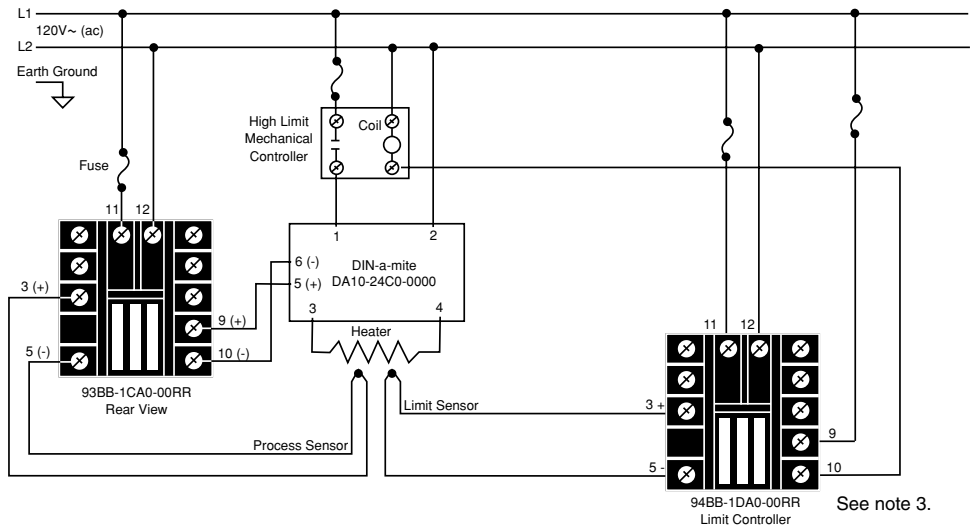

NOTE 1:

Switching inductive loads (relay coils, solenoids, etc.) with the mechanical relay, solid-state relay output options requires use of an R.C. suppressor.

Watlow carries the R.C. suppressor Quencharc brand name, which is a trademark of ITW Paktron. Watlow Part No. 0804-0147-0000.



WARNING: To avoid damage to property and equipment, and/or injury or loss of life, use National Electric Code (NEC) standard wiring practices to install and operate the Series 94. Failure to do so could result in such damage, and/or injury or death.

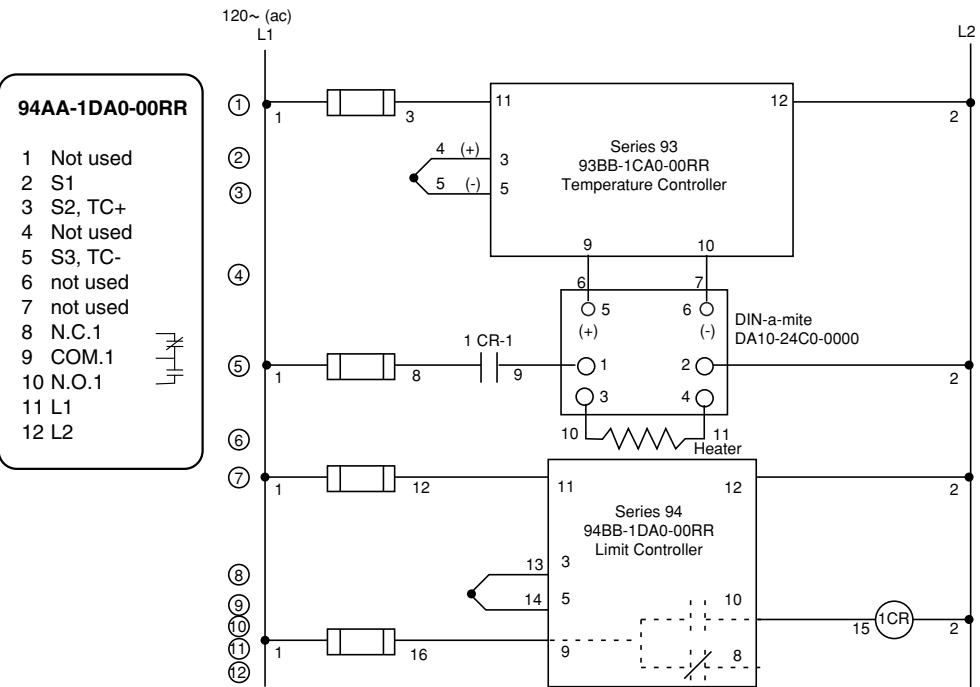

Figure 2.7 - System wiring example.

Wiring Notes

Sketch in your application on this page or a copy of it. See the wiring example in this chapter.

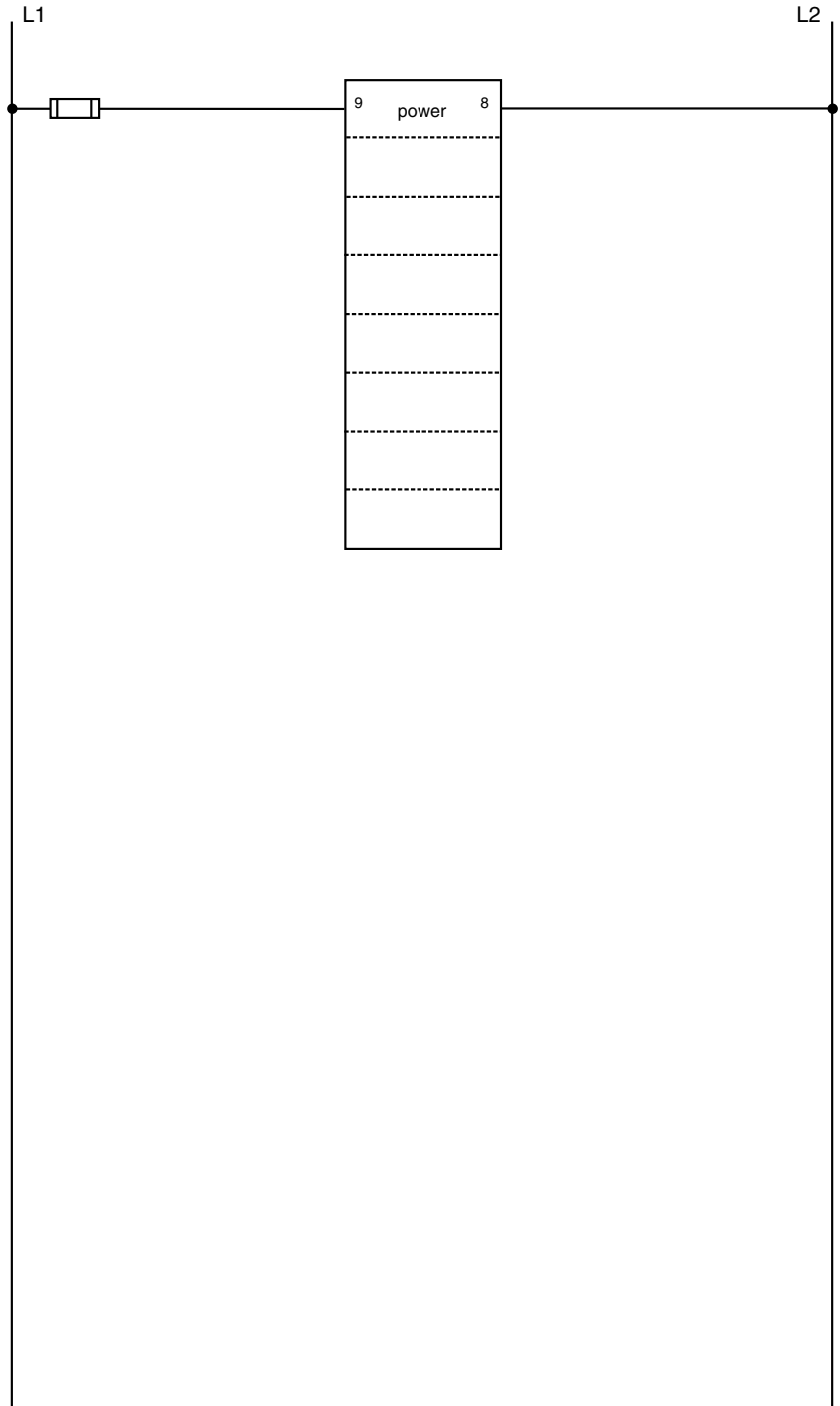

Figure 2.8 - Wiring notes.

3

How to Use the Keys and Displays

After one minute with no key activations, the controller reverts to the default displays.

Lower Display: Can indicate actual temperature, alarm low, alarm high, limit low set point value, limit high set point value, output value, parameters for data in the upper display, or error and alarm codes.

- To set to blank: set `[b a t]` to `[n o]` in the Setup Menu.

Upper Display: Can indicate actual temperature, alarm low, alarm high, limit low set point value, limit high set point value, operating parameter values or an open sensor. When powering up, the upper display will be blank for five seconds.

- To set to blank: set `[u p]` to `[n o]` in the Setup Menu.

Advance Key: Press to step through the Operation, Setup and Calibration Menus.

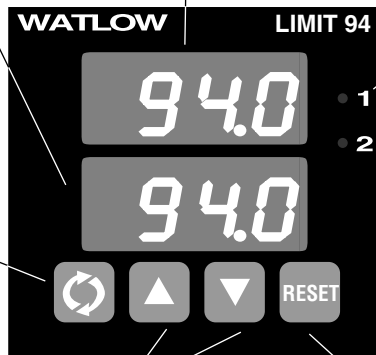

Output 1 Indicator Light: Lit when limit output is tripped.

Output 2 Indicator Light: Lit when alarm output is tripped.

Up-arrow and Down-arrow Keys: Increases or decreases the value of the displayed parameter.

- Press once to increase or decrease the value by one.

- Press and hold down to increase or decrease the displayed value at a rapid rate. New data will self-enter in five seconds, or can be entered by pressing the Advance Key.

- Press both simultaneously for three seconds to enter the Setup Menu. The `[L O C]` Lock parameter appears.

- Continue pressing both keys for three seconds to enter the Calibration Menu.

RESET Key

- Press once to clear any limits and latched alarms.
- Press once to silence alarm output if silence is enabled.
- Automatic reset on power loss.

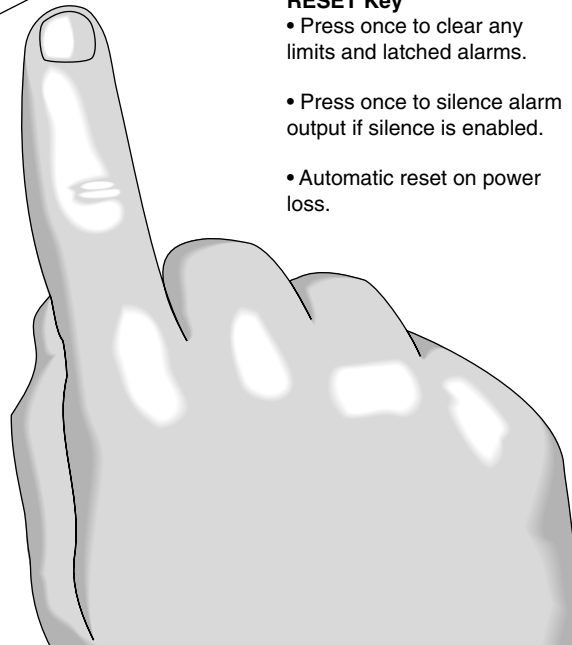

Figure 3.1 - Series 94 Keys and Displays

Notes

Keys and Displays



4

How to Set Up the Series 94



WARNING:

Remove power from the controller before removing the chassis from the case or changing the DIP switches. Removing the controller from the chassis is not a normal operating condition and should only be done by a qualified technician.

Setting up the Series 94 is a simple process. First set the DIP switches to match your input type. Refer to the orientation below for the  Input parameter. Next, configure the 94's features to your application in the Setup Menu, then enter values in the Operation Menu. Both tasks use the  Advance key to move through the menus and the Up-arrow/Down-arrow keys to select data.

Setting the Input Type DIP Switch

The Series 94 input type can be user selectable at any time via a Dual In-line Package (DIP) switch inside the control, located on the left (viewed from the bottom). To set the DIP switch, remove the control chassis from the case. Holding each side of the bezel, press in firmly on the side grips until the tabs release. You may need to rock the bezel back and forth several times to release the chassis.

The locations of the board and switches appear in Figures 1a and 4.1b. Refer to the input types below for DIP switch orientation. DIP switch selection must match the sensor selected under the  Input parameter in the Setup Menu. Set the software selection for the input type to match.

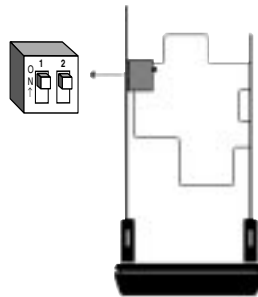
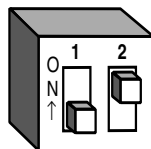

Figure 4.1a -
DIP Switch Location and
Orientation.

Controller Chassis -
Bottom View

Thermocouple



RTD

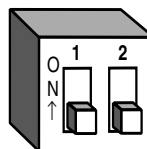

Figure 4.1b -
Input DIP Switches.

Input Types

Entering the Setup Menu

The Operation Menu will appear as the default menu of the Series 94. The Setup Menu displays the parameters that configure the Series 94's features to your application.

Enter the Setup Menu by pressing the ▲Up-arrow and ▼Down-arrow keys simultaneously for 3 seconds. The lower display shows the **LOC** Lock parameter, and the upper display shows its current level. All keys are inactive until you release both keys. You can reach the **LOC** Lock parameter from anywhere.

Figure 4.2a - Entering the Setup Menu.

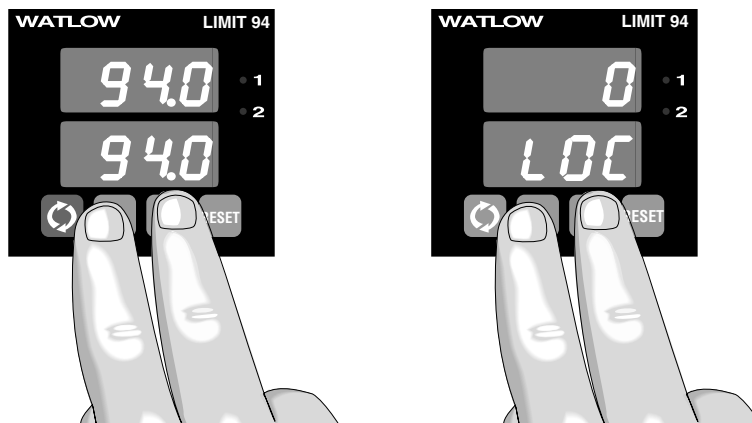

Use the ⏩Advance key to move through the menus and the ▲Up-arrow and ▼Down-arrow keys to select data. You will not see all parameters in this menu, depending on the controller's configuration and model number. If no keys are pressed for approximately 60 seconds, the controller returns to the default display.

NOTE:

While in the Setup Menu, all outputs are off.

Figure 4.2b - The Setup Menu.

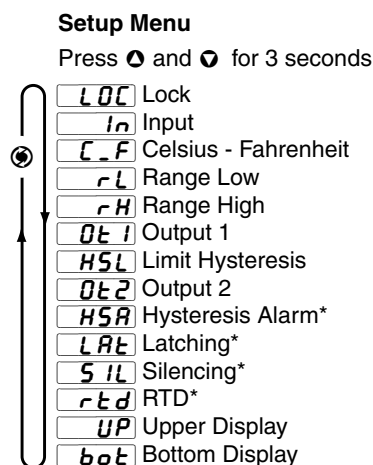

* These parameters may be masked or hidden, depending on the settings of your controller. For an explanation of when the parameters will appear, refer to Table 4.5b on page 4.5.

Setup Parameters

NOTE:

Shaded parameters may not appear, depending on the controller's configuration and model number.

LOC

NOTE:

Set the **LOC** Lock parameter value as the final step in programming the Series 94 controller to prevent locking yourself out of the Operation and Setup Menu during initial programming.



CAUTION: Changing the **In** Input parameters lets all parameters to factory defaults. Document all settings before changing this parameter.

In

C_F

rL

rH

At the top of the Setup Menu the Series 94 displays the user level of operation in the upper display and the **LOC** Lock parameter in the lower display.

Press the **⊕** Advance key and the value of the next parameter appears in the upper display, and the parameter appears in the lower display.

Lock: Selects the level of operator lock-out as defined below.

Range: 0 - 3

Default: 0

0 No level of lockout. The user has full access to all prompts and menus.

1 The Setup Menu will be locked from view except for the **LOC** prompt, which can be viewed and changed. The user will be able to change and view all prompts in the Operation Menu.

2 The Setup Menu will be locked from view except for the **LOC** prompt, which can be viewed and changed. The user will be able to change the limit low and limit high set points only. All prompts except for the **LLO** and **LHI** in the Operation Menu will be locked from view.

3 Full lockout of prompts and menus. All prompts in the Operation and Setup Menus will be locked from view. The operator can use the Reset Key for clearing limits and alarms, and for silencing alarms. The operator can also use the **⬆** Up-arrow and **⬇** Down-arrow keys to access the **LOC** prompt in the Setup Menu, which can be viewed and changed.

Input: Selects the sensor input type. The internal DIP switch must also match the **In** Input parameter. See Figure 4.1b for DIP switch orientation. Refer to Table 4.5a on page 4.5 for input type temperature ranges.

Range: **J**, **H** (K), **t**, **n**, **S**, **b**, **rtd**, **rtd**
Default: **J**

Celsius _ Fahrenheit: Selects the units of temperature measurement for the control.

Range: **C**, **F**

Default: **F**

Range Low: Selects the low range of the limit set point. See the specifications information in the Appendix for your range values, or refer to Table 4.5a on page 4.5.

Range: Sensor range low to **rH**

Default: Low range of sensor type

Range High: Selects the high range of the limit set point. See the specifications information in the Appendix for your range values, or refer to Table 4.5a on page 4.5.

Range: Sensor range high to **rL**

Default: High range of sensor type

OL1

Output 1: Selects which side or sides the limit setpoints can be programmed for. Select **HI** for high side, select **LO** for low side or **H-L** for both.
Range: **HI**, **LO**, **H-L**
Default: **H-L**

HSL

Hysteresis - Limit: Selects the switching hysteresis for Output 1.
Range: 1 to 9999, 0.1 to 999.9°F/1 to 5555, 0.1 to 555.5°C
Default: 3, 0.3°F/2, 0.2°C

OL2

Output 2: Selects the output action for Output 2.
Range: **PrA** Process alarm with alarm message displayed
 Pr Process alarm with no alarm message displayed
 no None
Default: **no**

HSR

Hysteresis - Alarm: Selects the switching hysteresis for Output 2 when **OL2** is an alarm. Appears only if **OL2** is set to **PrA** or **Pr**.
Range: 1 to 9999, 0.1 to 999.9°F/1 to 5555, 0.1 to 555.5°C
Default: 3, 0.3°F/2, 0.2°C

LAL

Latching: Selects whether the alarm is latching or non-latching. Latching alarms must be cleared by pressing the Reset Key. Selecting non-latching will automatically reset the alarm output when the condition clears. Appears only if **OL2** is set to **PrA** or **Pr**.
Range: **LAL** or **nLA**
Default: **nLA**

SIL

Silencing: Selects alarm silencing (inhibit) for the alarm. Appears only when **OL2** is set to **PrA** or **Pr**. For more information see Chapter 5.
Range: **On** or **OFF**
Default: **OFF**

RTD

RTD: Selects the RTD calibration curve for RTD inputs. Will not appear unless **In** is set to **RTD** or **RTD**. **J15** is 0.003916Ω/Ω°C, **d in** is 0.003850Ω/Ω°C.
Range: **d in** or **J15**
Default: **d in**

UP

Upper Display: Selects what parameter appears on the upper display.
Range: **no** No display
 Pro Process temperature
 LoL Low limit set point
 HiL High limit set point
 LoA Low alarm set point
 HiA High alarm set point
Default: **Pro**

bot

Bottom Display (Lower): Selects what parameter appears on the lower display.
Range: **no** No display
 Pro Process temperature
 LoL Low limit set point
 HiL High limit set point
 LoA Low alarm set point
 HiA High alarm set point
Default: **HiL**

**Table 4.5a -
Input Ranges.**

Input Type	Sensor Range Low	Sensor Range High
<input type="checkbox"/> J	32°F/0°C	1382°F/750°C
<input type="checkbox"/> H (K)	-328°F/-200°C	2282°F/1250°C
<input type="checkbox"/> E	-328°F/-200°C	662°F/350°C
<input type="checkbox"/> n	32°F/0°C	2282°F/1250°C
<input type="checkbox"/> S	32°F/0°C	2642°F/1450°C
<input type="checkbox"/> b	32°F/0°C	3308°F/1820°C
<input type="checkbox"/> rtd (1°)	-328°F/-200°C	1292°F/700°C
<input type="checkbox"/> rtd (0.1°)	-199.9°F/-199.9°C	999.9°F/700.0°C

Setup Menu

**Table 4.5b -
Setup Menu Prompts
and Descriptions.**

NOTE:

**Document your setup menu parameters.
Do not enter any values here; make photocopies instead.**

Parameter	Value	Range	Factory Default	Appears If:
<input type="checkbox"/> LOC		0 - 3	0	
<input type="checkbox"/> In		<input type="checkbox"/> J, <input type="checkbox"/> H (K), <input type="checkbox"/> E, <input type="checkbox"/> n, <input type="checkbox"/> S, <input type="checkbox"/> b, <input type="checkbox"/> rtd, <input type="checkbox"/> rtd	<input type="checkbox"/> J	DIP switch selectable.
<input type="checkbox"/> C_F		<input type="checkbox"/> C or <input type="checkbox"/> F	<input type="checkbox"/> F	<input type="checkbox"/> LOC is set to <input type="checkbox"/> 0
<input type="checkbox"/> rL		<input type="checkbox"/> rL to <input type="checkbox"/> rh	Input dependent.	<input type="checkbox"/> LOC is set to <input type="checkbox"/> 0
<input type="checkbox"/> rh		<input type="checkbox"/> rh to <input type="checkbox"/> rL	Input dependent.	<input type="checkbox"/> LOC is set to <input type="checkbox"/> 0
<input type="checkbox"/> DE1		<input type="checkbox"/> HI, <input type="checkbox"/> LO, <input type="checkbox"/> H_L	<input type="checkbox"/> H_L	<input type="checkbox"/> LOC is set to <input type="checkbox"/> 0
<input type="checkbox"/> HSL		1 - 9999, 0.1 - 999.9°F 1 to 5555, 0.1 to 555.5°C	3, 0.3°F 2, 0.2°C	<input type="checkbox"/> LOC is set to <input type="checkbox"/> 0
<input type="checkbox"/> DE2		<input type="checkbox"/> PrA = Process Alarm <input type="checkbox"/> Pr = Process with no alarm message <input type="checkbox"/> no = None	<input type="checkbox"/> no	<input type="checkbox"/> LOC is set to <input type="checkbox"/> 0
<input type="checkbox"/> HSA		1 - 9999, 0.1 - 999.9°F 1 - 5555, 0.1 - 555.5°C	3, 0.3°F 2, 0.2°C	<input type="checkbox"/> DE2 is set to <input type="checkbox"/> Pr or <input type="checkbox"/> PrA and <input type="checkbox"/> LOC is set to <input type="checkbox"/> 0
<input type="checkbox"/> LAE		<input type="checkbox"/> LAE or <input type="checkbox"/> nLA	<input type="checkbox"/> nLA	<input type="checkbox"/> DE2 is set to <input type="checkbox"/> Pr or <input type="checkbox"/> PrA and <input type="checkbox"/> LOC is set to <input type="checkbox"/> 0
<input type="checkbox"/> SIL		<input type="checkbox"/> On or <input type="checkbox"/> OFF	<input type="checkbox"/> OFF	<input type="checkbox"/> DE2 is set to <input type="checkbox"/> Pr or <input type="checkbox"/> PrA and <input type="checkbox"/> LOC is set to <input type="checkbox"/> 0
<input type="checkbox"/> rtd		<input type="checkbox"/> JIS or <input type="checkbox"/> din	<input type="checkbox"/> din	<input type="checkbox"/> In is set to <input type="checkbox"/> rtd or <input type="checkbox"/> rtd and <input type="checkbox"/> LOC is set to <input type="checkbox"/> 0
<input type="checkbox"/> UP		<input type="checkbox"/> no = no display shown <input type="checkbox"/> Pro = Process <input type="checkbox"/> LoL = Low limit set point <input type="checkbox"/> HiL = High limit set point <input type="checkbox"/> LoA = Alarm low set point <input type="checkbox"/> HiA = Alarm high set point	<input type="checkbox"/> Pro	<input type="checkbox"/> LOC is set to <input type="checkbox"/> 0
<input type="checkbox"/> bat		<input type="checkbox"/> no = no display shown <input type="checkbox"/> Pro = Process <input type="checkbox"/> LoL = Low limit set point <input type="checkbox"/> HiL = High limit set point <input type="checkbox"/> LoA = Alarm low set point <input type="checkbox"/> HiA = Alarm high set point	<input type="checkbox"/> HiL	<input type="checkbox"/> LOC is set to <input type="checkbox"/> 0

Setup

Operation Menu

Figure 4.6 -
The Operation Menu.

NOTE:

Shaded parameters may not appear, depending on the controller's configuration and model number.

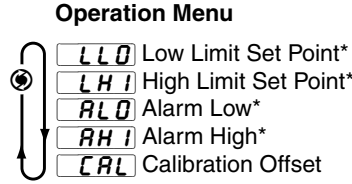

* These parameters may be masked or hidden, depending on the settings of your controller. For an explanation of when the parameters will appear, refer to Table 4.6 below.

Operation Parameters

LLO

Low Limit Set Point Sets the low limit set point. Active if **DE1** is set to **H_L** or **LO**.
Range: **rL** to **LHI**, or **rH** if **LHI** is not active.

LHI

High Limit Set Point Sets the high limit set point. Active if **DE1** is set to **H_L** or **HI**.
Range: **LLO** to **rH**, or **rL** if **LLO** is not active.

ALO

Alarm Low: Represents the low process alarm. This parameter will not appear if **DE2** is set to **no**. This parameter is present if **DE2** is set to **PrA** or **Pr** and **LDC** is set to **0** or **1**.
Range: **rL** to **AHI**, or **rH** if **AHI** is not active. **Default:** **rL**

AHI

Alarm High: Represents the high process alarm. This parameter will not appear if **DE2** is set to **no**. This parameter is present if **DE2** is set to **PrA** or **Pr** and **LDC** is set to **0** or **1**.
Range: **ALO** to **rH**, or **rL** if **ALO** is not active. **Default:** **rH**

CAL

Calibration Offset: Adds or subtracts degrees from the input signal.
Range: -180°F to 180°F/-100°C to 100°C;
or -18.0°F to 18.0°F/-10.0°C to 10.0°C **Default:** 0

Setup

Table 4.6 -
Operation Menu
Prompts and Descriptions.

Operation Menu

Document your Series 94 Operation Parameters
Do not enter any values here; make photocopies instead.

Operation Parameters	Value	Range	Factory Default	Appears If
<input type="checkbox"/> LLO		<input type="checkbox"/> rL to <input type="checkbox"/> LHI or <input type="checkbox"/> rH if <input type="checkbox"/> LHI is not active	<input type="checkbox"/> rL	<input type="checkbox"/> DE1 is set to <input type="checkbox"/> H_L or <input type="checkbox"/> LO and <input type="checkbox"/> LDC is not set to <input type="checkbox"/> 3 .
<input type="checkbox"/> LHI		<input type="checkbox"/> LLO to <input type="checkbox"/> rH or <input type="checkbox"/> rL if <input type="checkbox"/> LLO is not active	<input type="checkbox"/> rH	<input type="checkbox"/> DE1 is set to <input type="checkbox"/> H_L or <input type="checkbox"/> HI and <input type="checkbox"/> LDC is not set to <input type="checkbox"/> 3 .
<input type="checkbox"/> ALO		<input type="checkbox"/> rL to <input type="checkbox"/> AHI or <input type="checkbox"/> rH if <input type="checkbox"/> AHI is not active	<input type="checkbox"/> rL	<input type="checkbox"/> DE2 is set to <input type="checkbox"/> PrA or <input type="checkbox"/> Pr and <input type="checkbox"/> LDC is set to <input type="checkbox"/> 0 or <input type="checkbox"/> 1 .
<input type="checkbox"/> AHI		<input type="checkbox"/> ALO to <input type="checkbox"/> rH or <input type="checkbox"/> rL if <input type="checkbox"/> ALO is not active	<input type="checkbox"/> rH	<input type="checkbox"/> DE2 is set to <input type="checkbox"/> PrA or <input type="checkbox"/> Pr and <input type="checkbox"/> LDC is set to <input type="checkbox"/> 0 or <input type="checkbox"/> 1 .
<input type="checkbox"/> CAL		-180°F to 180°F/-100°C to 100°C; or -18.0°F to 18.0°F/-10.0°C to 10.0°C	0	<input type="checkbox"/> LDC is set to <input type="checkbox"/> 0 or <input type="checkbox"/> 1 .

5

Alarms and Errors

Using Alarms

NOTE:

When the alarm output is de-energized, the N.O. contact is open in the alarm condition.

The Series 94 has a **process alarm** feature. When the actual temperature exceeds that absolute temperature limit an alarm occurs. The process alarm set points may be independently set high and low. Under the Setup Menu, select the type of alarm output with the **DE2** Output 2 Parameter. **PrA** sets a Process Alarm with alarm message displayed. **Pr** sets a Process alarm with no alarm message displayed.

Latching: Process alarms can be latching or non-latching. When the alarm condition is removed a **non-latching alarm automatically** clears the alarm output. You must **manually clear a latching alarm** before it will disappear by pressing the RESET key.

Flashing **LO** or **HI** in the lower display indicates an alarm when **DE2** is set to **PrA**. The lower display alternately shows information from the current parameter and the **LO** or **HI** alarm message at one second intervals. The alarm output is de-energized and the Output 2 indicator light is lit.

To clear an alarm: First correct the alarm condition, then:

- **If the alarm is latching...**

Clear it manually; press the Reset key once as soon as the process temperature is inside the alarm limits and satisfies the alarm hysteresis **HSA**.

- **If the alarm is non-latching...**

The alarm clears itself automatically as soon as the process temperature is inside the alarm limits and satisfies the alarm hysteresis **HSA**.

Figure 5.1 - Clearing a latching alarm.

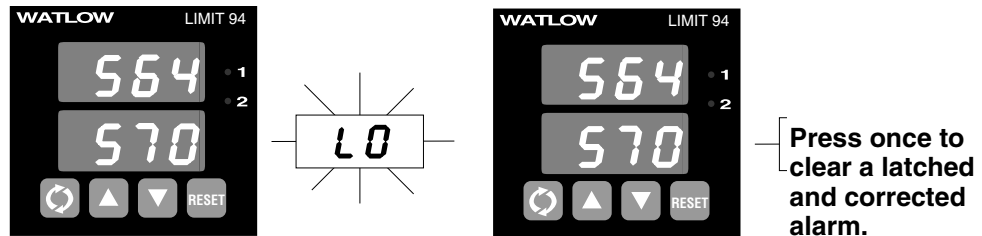

Alarm Silencing is available with the process alarm and has two uses:

When **SIL** is selected as “on,” the controller automatically disables the alarm output on initial power up (in either the latching or non-latching mode). Alarm silencing disables the alarm output relay and the Output 2 indicator light. Once the process value crosses into the “safe” region, both a latching or a non-latching alarm is ready. Any future excursion outside of these alarm set points triggers an alarm.

When **SIL** is selected as “on,” pressing the Reset Key will disable the alarm output relay and the Output 2 indicator light once an alarm has occurred, but will not eliminate the alarm message if enabled. (If **DE2** is set to **PrA**.) This silences the alarm until the process returns to the “safe” region. Once within this region, the alarm is ready again. Any future excursion outside of the alarm set points triggers an alarm.

Error Code Messages

Three dashes [- - -] in the upper display indicate a Series 94 error. The error code is visible in the lower display.

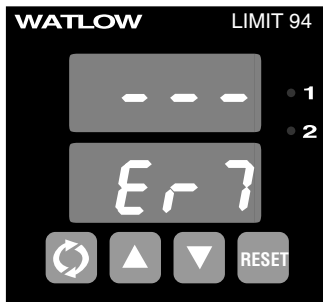

Figure 5.2 -
Error Code Message.

[Er 2] - Sensor underrange error (applies only to RTD units)

The sensor input generated a value lower than the allowable signal range, or the A/D circuitry malfunctioned. Enter a valid input. Make sure the [In] Input parameter (Setup Menu) and the DIP switch settings both match your sensor. Refer to Table 4.5b on page 4.5 for the appropriate input type and range.

[Er 4] - Configuration error

The controller's microprocessor is faulty; call the factory.

[Er 5] - Non volatile checksum error

The nonvolatile memory checksum discovered a checksum error. Unless a momentary power interruption occurred while the controller was storing data, the nonvolatile memory is bad. Call the factory.

[Er 6] - A/D underflow error



The A/D circuit is underrange. An open or reversed polarity sensor is the most likely cause. Check the sensor; if the connection is good and functions properly, call the factory. The A/D underrange voltage is too low to convert an A/D signal. Make sure the [In] Input parameter matches your sensor and DIP switches are set accordingly.

[Er 7] - A/D overflow error

The A/D circuit is overrange. An open or reversed polarity sensor is the most likely cause. Check the sensor; if the connection is good, and the sensor functions properly, call the factory. The A/D overrange voltage is too high to convert an A/D signal. Make sure the [In] Input parameter (Setup Menu) matches your sensor and DIP switches are set accordingly.

Error Code Actions

[Er 2], [Er 6], [Er 7]

To clear a corrected error, press the  Advance key to clear the input error code. Wait for the upper display to change from showing [- - -] to showing the process temperature. The Limit message [Err] will appear. Then press the RESET key to clear/reset the error latched outputs. There may be a 30 second delay from when the  Advance key is pressed.

[Er 4] and [Er 5] result in these conditions:

- Both outputs will turn off.
- The alarm output, if present, will be in an alarm state (de-energized with the indicator light on).
- The upper display indicates the process value.
- The lower display indicates the error code.
- All keys are inactive.
- All Setup Menu parameters return to default values.
- The above conditions occur regardless of the value of [LOC], or the presence of the Setup or Calibration Menus.

To clear a corrected error cycle power to the controller or press the RESET key.



CAUTION:

Electrical noise or a noise event, vibration or excess environmental moisture or temperature may cause Series 94 errors to occur. If the cause of an error is not otherwise apparent, check for these.

Noise and Installation Guidelines

For wiring guidelines, refer to the IEEE Standard No. 518-1982, available from IEEE, Inc. 345 East 47th Street, New York, NY 10017.

Noise Sources

- Switches and relay contacts operating inductive loads such as motors, coils, solenoids, and relays, etc.
- Thyristors or other semiconductor devices which are not zero crossover-fired (randomly-fired or phase angle-fired devices).
- All welding machinery and heavy current carrying conductors.
- Fluorescent and neon lights.

Decreasing Noise Sensitivity

- Physical separation and wire routing must be given careful consideration in planning the system layout. For example, ac power supply lines should be bundled together and physically kept separate from input signal lines (sensor lines). A 12" (305 mm) minimum separation is usually effective. Keep all switched output signal lines (high power level) separate from input signal lines (sensor lines). Cross other wiring at 90° angles whenever crossing lines is unavoidable.
- Look at the system layout; identify and locate electrical noise sources such as solenoids, relay contacts, motors, etc. Route the wire bundles and cables as far away as possible from these noise sources. Don't mount relays or switching devices close to a microprocessor control. Don't have phase angle-fired devices in the same electrical enclosure or on the same power line with the control.
- Shielded cables should be used for all low power signal lines to protect from magnetic and electrostatic coupling of noise. Some simple pointers are:
 - ◇ Whenever possible, run low level signal lines unbroken from signal source to the control circuit.
 - ◇ Connect the shield to the control circuit common at the control end only. Never leave the shield unconnected at both ends. Never connect both shield ends to a common or ground.
 - ◇ Maintain shield continuity at daisy chain connection points by reconnecting the broken shield.
 - ◇ Assume no electrostatic shielding when using the shield as a signal return. If you must do this, use triaxial cable (electrostatically shielded coaxial cable).

- Use twisted pair wire any time control circuit signals must travel over two feet, or when you bundle them in parallel with other wires.
- Select the size or gauge of wire by calculating the maximum circuit current and choosing the gauge meeting that requirement. Using greatly larger wire sizes than required generally increases the likelihood of electrostatic (capacitance) coupling of noise.
- Eliminate ground loops in the entire control system. You can spot the obvious loops by studying the “as-built” wiring diagram. There are also not-so-obvious ground loops resulting from connecting internal circuit commons in the manufacturer’s equipment.
- Do not daisy chain ac power (or return) lines, or output signal (or return) lines to multiple control circuits. Use a direct line from the power source to each input requiring ac power. Avoid paralleling L1 (power lead) and L2 (return lead) to load power solenoids, contactors, and control circuits. If an application uses L1 (power lead) to switch a load, L2 (return lead) has the same switched signal and could couple unwanted noise into a control circuit.
- Tie all ground terminals together with one lead (usually green wire) tied to ground at one point. Don’t connect ground to the control case if the control is in a grounded enclosure (preventing ground loops).
- Do not confuse chassis grounds (safety ground) with control circuit commons or with ac supply L2 (return or neutral line). Each return system wiring must be separate. Absolutely never use chassis ground (safety) as a conductor to return circuit current.

Eliminating Noise

- Use “snubbers” (QUENCHARC™ P/N: 0804-0147-0000) to filter out noise generated by relays, relay contacts, solenoids, motors, etc. A snubber is a simple filter device using a 0.1µf, 600 volt, non-polarized capacitor in series with a 100Ω, 1/2 watt resistor. The device can be used on ac or dc circuits to effectively dampen noise at its source. Refer to output wiring in Chapter Two for proper Quencharc installation.
- The ultimate protection is an “uninterruptable” power supply. This “senses” the ac power line; when the line fluctuates, a battery powered 60Hz inverted circuit takes over, supplying power within one-half to one cycle of the ac line; very expensive.

Calibration

Before attempting to calibrate, make sure you read through the procedures carefully and have the proper equipment called for in each procedure. Make sure the DIP switches are in the proper position for the input type. See Chapter 4.

Entering the Calibration Menu

In the Calibration Menu, various input signals must be supplied for the controller to go through its auto calibration. The Calibration Menu can only be entered from the **LOC** Lock parameter in the Setup Menu. Press the **▲**Up-arrow/**▼**Down-arrow keys simultaneously for 3 seconds (± 1 second). The **CAL** Calibration Offset parameter appears in the lower display with "no" in the upper display.

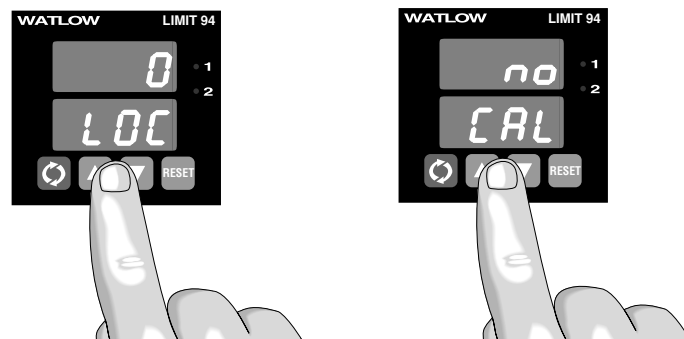

Figure A.3 - Entering the Calibration Menu.

NOTE:
Calibration values will not be retained unless Output 2 indicator light is on. Do not press the RESET key twice until you are at the correct input parameters.

NOTE:
While in the Calibration Menu, the controller outputs are disabled.

Any inadvertent change in the displayed data, when pressing the **▲**Up-arrow/**▼**Down-arrow keys, is ignored. Calibration values won't be retained unless Output 2 indicator light is on. To turn Output 2 indicator light on, press the RESET key two times within three seconds. Press the **▲**Up-arrow or **▼**Down-arrow key to change the upper display to **YES**. Press **▶**Advance to enter the calibration sequence.

Upon entering the calibration menu, the upper display window indicates **CAL**. It continues to indicate **CAL** while the operator walks through the entire calibration parameter list. The controller uses the lower display to prompt the user as to what the input should be.

Once the information has been properly established and maintained for at least 5 to 10 seconds, the **▶**Advance key may then be used to display the next prompt. After the final input is established, press the **▶**Advance key twice to return the controller to the configuration menu at the top of the parameter list.

Restoring Factory Calibration

The **[rSE]** Restore Factory Calibration parameter restores the factory calibration values to the Series 94. If you calibrate your control incorrectly, you have the option to default to the original values. Once you leave the **[CAL]** menu, the values are entered.

1. Press the **▲Up-arrow/▼Down-arrow** keys simultaneously for three seconds. The LOC parameter appears in the lower display. Continue holding the **▲Up-arrow/▼Down-arrow** keys simultaneously for three seconds until the lower display reads **[CAL]**.
2. Press the **▲Up-arrow** key until **[YES]** appears in the upper display.
3. **⊙**Advance through the calibration menu until **[rSE]** appears in the lower display.
4. Press the **▲Up-arrow** key until **[YES]** appears in the upper display.
5. Press the **⊙**Advance key and the Series 94 advances to test the displays.

This procedure is used only to restore calibration, it does not affect Setup or Operation parameters or values.

Calibration Menu

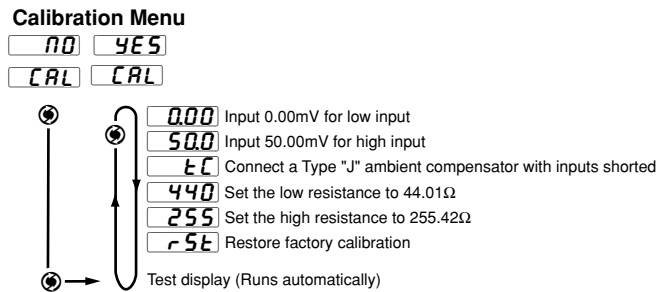

Figure A.4 - Calibration Parameters.



Before attempting to calibrate, make sure you have the proper equipment called for in each procedure. The Series 94 is calibrated and tested before it leaves the factory.

Thermocouple Field Calibration Procedure

Equipment Required

- Type "J" Reference Compensator with reference junction at 32°F/0°C or Type "J" Thermocouple Calibrator set at 32°F/0°C.
- Precision millivolt source, 0-50mV min. range, 0.01mV resolution

NOTE:

Before calibration on an installed controller, make sure all data and parameters are documented. See the Setup and Operation Tables in Chapter Four.

Setup And Calibration

1. Connect the ac line voltage L1 and L2 to the proper terminals.
2. Connect the millivolt source to Terminal 5 Negative and Terminal 3 Positive on the Series 94 terminal strip. Use regular 20 - 24 gauge wire. Make sure the DIP switch is set for thermocouple input. See Chapter 4.
3. Apply power to the controller and allow it to warm up for 15 minutes. **After warm-up** put the controller in the Calibration Menu. Select **[4E5]**.
4. Press the Reset Key twice to turn on Output 2 indicator light. The unit is calibrating when Output 2 indicator light is on. Make sure you are in the correct parameters when Output 2 indicator light is on.
5. Press the **⏩** Advance key once to get to the **[0.00]** prompt. At the 0.00 prompt, enter 0.00mV from the millivolt source to the Series 94. Allow at least 10 seconds to stabilize. Press the **⏩** Advance key.
6. At the 50.0 prompt, enter 50.00mV from the millivolt source to the Series 94. Allow at least 10 seconds to stabilize. Press the **⏩** Advance key.
7. At the **[5E]** prompt, disconnect the millivolt source, and connect the reference compensator or thermocouple calibrator to Terminal 5 Negative and Terminal 3 Positive on the Series 94 terminal strip. If using a compensator, turn on and short the input wires. If using "J" calibrator, set to simulate 32°F/0°C. Allow 10 seconds for the control to stabilize, then press the Reset Key twice to turn off Output 2 indicator light. The unit will leave the calibration mode if one minute passes between key activations. To conclude the thermocouple calibration, press the **⏩** Advance key to the next prompt or exit the Calibration Menu.

RTD Field Calibration Procedure

Equipment Required

- 1KΩ precision decade resistance box with 0.01Ω resolution.

Setup And Calibration

1. Connect the ac line voltage L1 and L2 to the proper terminals.
2. Connect the decade resistance box to Terminal 2, 3 and 5 on the terminal strip. Use regular 20 - 24 gauge wire of the same length and type. Make sure the DIP switch is set for RTD input, see Chapter 4.
3. Apply power to the unit and allow it to warm up for 15 minutes. **After warm-up** put the controller in the Calibration Menu. Select **[4E5]**. Press the **⏩** Advance key until the **[440]** prompt is displayed.
4. Press the Reset Key twice to turn on Output 2 indicator light. The controller is calibrating when Output 2 indicator light is on. Make sure you are in the correct parameters when Output 2 indicator light is on.
5. At the **[440]** prompt, set the decade resistance box to 44.01. Allow at least 10 seconds to stabilize. Press the **⏩** Advance key.
6. At the **[255]** prompt, set the decade resistance box to 255.42. Allow at least 10 seconds to stabilize. Press the Reset Key twice to turn off Output 2 indicator light. The unit will leave the calibration mode if one minute passes between key activations. To conclude the RTD calibration, press the **⏩** Advance key to the next prompt or exit the Calibration Menu.

NOTE:

When the Output 2 indicator light is on, the controller is automatically calibrating. Your sequence is VERY important. Always move to the next parameter before changing the calibration equipment.

Notes

Glossary

A - B

alarm A signal that indicates that the process has exceeded or fallen below the alarm set point. For example, an alarm may indicate that a process is too hot or too cold.

alarm hysteresis A change in the process variable required to re-energize the alarm output.

alarm silence A feature that disables the alarm relay output.

automatic prompts Data entry points where a microprocessor-based controller asks the operator to enter a control value.

C

calibration offset An adjustment to eliminate the difference between the indicated value and the actual process value.

CE A manufacturer's mark that demonstrates compliance with European Union (EU) laws governing products sold in Europe.

CE-compliant Compliant with the essential requirements of European directives pertaining to safety and/or electromagnetic compatibility.

closed loop A control system that uses a sensor to measure a process variable and makes decisions based on that input.

cold junction See junction, cold.

cold junction compensation Electronic means to compensate for the effective temperature at the cold junction.

compensation, ambient The ability of an instrument to adjust for changes in the temperature of the environment and correct the readings. Sensors are most accurate when maintained at a constant ambient temperature. When temperature changes, output drifts.

control action The response of the control output relative to the error between the process variable and the set point. For reverse action (usually heating), as the process decreases below the set point, the output increases. For direct action (usually cooling), as the process increases above the set point, the output increases.

D - E

default parameters The programmed instructions that are permanently stored in the microprocessor software.

direct action An output control action in which an increase in the process variable causes an increase in the output. Cooling applications usually use direct action.

display capability In an instrument with digital display, the entire possible span of a particular parameter or value.

F - G

Form A A single-pole, single-throw relay that uses only the normally open (NO) and common contacts. These contacts close when the relay coil is energized. They open when power is removed from the coil.

Form C A single-pole, double-throw relay that uses the normally open (NO), normally closed (NC) and common contacts.

H

hysteresis A change in the process variable required to re-energize the control or alarm output. Sometimes called switching differential.

I

isolation Electrical separation of sensor from high voltage circuitry. Allows use of grounded or ungrounded sensing element.

J - K

junction The point where two dissimilar metal conductors join to form a thermocouple.

junction, cold Connection point between thermocouple metals and the electronic instrument. See reference junction.

junction, reference The junction in a thermocouple circuit held at a stable, known temperature (cold junction). Standard reference temperature is 32°F (0°C).

L

limit or limit control A highly reliable, discrete safety device (redundant to the primary controller) that monitors and limits the temperature of the process, or a point in the process. When temperature exceeds or falls below the limit set point, the limit controller interrupts power through the load circuit. A limit control can protect equipment and people when it is correctly installed with its own power supply, power lines, switch and sensor.

M

manual mode A selectable mode that has no automatic control aspects. The operator sets output levels.

N

NEMA 4X A NEMA specification for determining resistance to moisture infiltration and corrosion resistance. This rating certifies the controller as washable and corrosion resistant.

O

on/off A method of control that turns the output full on until set point is reached, and then off until the process error exceeds the hysteresis.

open loop A control system with no sensory feedback.

output Control signal action in response to the difference between set point and process variable.

overshoot The amount by which a process variable exceeds the set point before it stabilizes.

P - Q

parallel circuit A circuit configuration in which the same voltage is applied to all components, with current divided among the components according to their respective resistances or impedances.

parameter A variable that is given a constant value for a specific application or process.

process variable The parameter that is controlled or measured. Typical examples are temperature, relative humidity, pressure, flow, fluid level, events, etc. The high process variable is the highest value of the process range, expressed in engineering units. The low process variable is the lowest value of the process range.

programmed display data Displayed information that gives the operator the intended process information, such as intended set point, intended alarm limit, etc., corresponding to temperature.

prompt A symbol or message displayed by the controller that requests input from the user.

R

reference junction See junction.

resistance temperature detector (RTD) A sensor that uses the resistance temperature characteristic to measure temperature. There are two basic types of RTDs: the wire RTD, which is usually made of platinum, and the thermistor, which is made of a semiconductor material. The wire RTD is a positive temperature coefficient sensor only, while the thermistor can have either a negative or positive temperature coefficient.

reverse action An output control action in which an increase in the process variable causes a decrease in the output. Heating applications usually use reverse action.

RTD See resistance temperature detector.

S

set point The desired value programmed into a controller. For example, the temperature at which a system is to be maintained.

switching sensitivity In on/off control, the temperature change necessary to change the output from full on to full off. See hysteresis.

T - Z

thermal system A regulated environment that consists of a heat source, heat transfer medium or load, sensing device and a control instrument.

thermocouple (t/c) A temperature sensing device made by joining two dissimilar metals. This junction produces an electrical voltage in proportion to the difference in temperature between the hot junction (sensing junction) and the leadwire connection to the instrument (cold junction).

thermocouple break protection The ability of a control to detect a break in the thermocouple circuit and take a predetermined action.

Specifications

(2291)

Control Mode

- Microprocessor-based, user selectable control modes
- Single input, dual output
- 2.5Hz Input Sampling Rate
- 1Hz Display Update Rate
- Automatic reset on power loss

Operator Interface

- Sealed membrane front panel
- Dual, four-digit red or green displays
- **▶** Advance, **▲** Up-arrow, **▼** Down-arrow, and Reset keys
- User selectable screen display

Accuracy

- Calibration accuracy $\pm 0.1\%$ of span $\pm 1^\circ\text{C}$ at standard conditions
Exceptions:
Type T; 0.12% of span for -200°C to -50°C ,
Types R and S; 0.15% of span for 0°C to 100°C
Types B; 0.24% of span for 870°C to 1700°C
- Accuracy span: $1000^\circ\text{F}/540^\circ\text{C}$ minimum
- Temperature stability: ± 0.1 degree per degree change in ambient

Sensors/Inputs

- Thermocouple, grounded or ungrounded sensors
- RTD 2- or 3-wire, platinum, 100Ω @ 0°C calibration to 0.003850 curve or 0.003916 curve; user selectable
- Sensor break protection de-energizes control output to protect system
- $^\circ\text{F}$ or $^\circ\text{C}$, user selectable

Input Range

Specified temperature ranges represent the controller's operational span.

• Thermocouple

Type J	32	to	1382°F
	(0	to	750°C)
Type K	-328	to	2282°F
	(-200	to	1250°C)
Type T	-328	to	662°F
	(-200	to	350°C)
Type N	32	to	2282°F
	(0	to	1250°C)
Type S	32	to	2642°F
	(0	to	1450°C)
Type B	32	to	3308°F
	(0	to	1820°C)

• RTD Resolution

1°	-328	to	1292°F
	(-200	to	700°C)
0.1°	-199.9	to	999.9°F
	(-199.9	to	700.0°C)

Output 1 (Limit)

- Electromechanical relay¹, Form C, 5A @ 120/240V~ maximum, without contact suppression, rated resistive load, 5A @ 30V \approx (dc)². Minimum contact current: 100mA @ 5V \approx (dc).

Output 2 (Alarm)

- Electromechanical relay¹, Form C, 5A @ 120/240V~ maximum, without contact suppression, rated resistive load, 5A @ 30V \approx (dc)². Minimum contact current: 100mA @ 5V \approx (dc).

- Switched dc signal provides a non-isolated minimum turn on voltage of 3V \approx (dc) into a minimum 500 Ω load; maximum on voltage not greater than 12V \approx (dc) into an infinite load.
- Solid-state relay², Form A, 0.5A @ 24V~ min., 264V~ max., opto-isolated burst fire switched, without contact suppression. Off-state output impedance is 31M Ω .
- Alarm output can be latching or non-latching, with separate high and low values. Alarm silencing (inhibit) on power up.

Output Configurations

• Output 1

- Limit output is latching

• Output 2

User selectable as:

- Latching or non-latching
- Process alarm with flashing alarm message
- Process without alarm message
- Alarm with separate high and low set points
- Hysteresis: 1 to 9999°F, 0.1-999.9°F/1 to 5555°C, 0.1 to 555.5°C switching differential

Line Voltage/Power

- 100-240V~, +10%³, -15%; (85-264V~) 50/60Hz, $\pm 5\%$, 12VA max.
- 12-24V \approx (ac/dc), +10%, -15%; (10-26V \approx [ac/dc]) 50/60Hz, $\pm 5\%$, 7 VA max.
- Data retention upon power failure via non-volatile memory

Operating Environment³

- 32 to 149°F (0 to 65°C)
- 0 to 90% RH, non-condensing

Storage Temperature

- -40° to 185°F (-40° to 85°C)

Terminals

- #6 compression universal head screw terminals, accepts 20-14 gauge wire
- Torque to 1.4 Nm (12 in-lb)

Controller Weight

- 0.4 lb (0.2 kg)

Shipping Weight

- 0.75 lb (0.34 kg)

Dimensions

- Compact 1/16 DIN size and IP65 (NEMA 4X)⁴, front panel makes the Series 94 easy to apply and maintain in a wide variety of applications. Unique mounting bezel, gasket and collar make installation a snap. Use Greenlee punch 60287.

Overall Height:	55 mm	(2.1 inches)
Width:	55 mm	(2.1 inches)
Depth:	120 mm	(4.7 inches)
Bezel Height:	55 mm	(2.1 inches)
Width:	55 mm	(2.1 inches)
Depth:	15 mm	(0.6 inches)
Chassis Height:	45 mm	(1.8 inches)
Width:	45 mm	(1.8 inches)
Depth:	105 mm	(4.1 inches)

Agency Approvals

- FM3545, File #J.I.OD5A1.AF
- IP65, NEMA 4X and NEMA 12⁴
- CE approved (See Declaration of Conformity)

- ¹ Electromechanical relays warranted for 100,000 closures only. Solid-state switching devices recommended for applications requiring fast cycle times or extended service life.
- ² Switching inductive loads (relay coils, etc.) requires using an RC suppressor. Quencharc from ITW PAKTRON is recommended, Watlow part number 0804-0147-0000.
- ³ Operating environment is 0 to 60°C for line voltage exceeding 240V.
- ⁴ To effect IP65 (NEMA 4X) rating requires a minimum mounting panel thickness of 1.5 mm (0.06 inch) and surface finish not rougher than 812 μ mm (0.32 μ inch). Use Greenlee punch 60287.

Series 94 Model Number Information

Ordering Information

(2292)

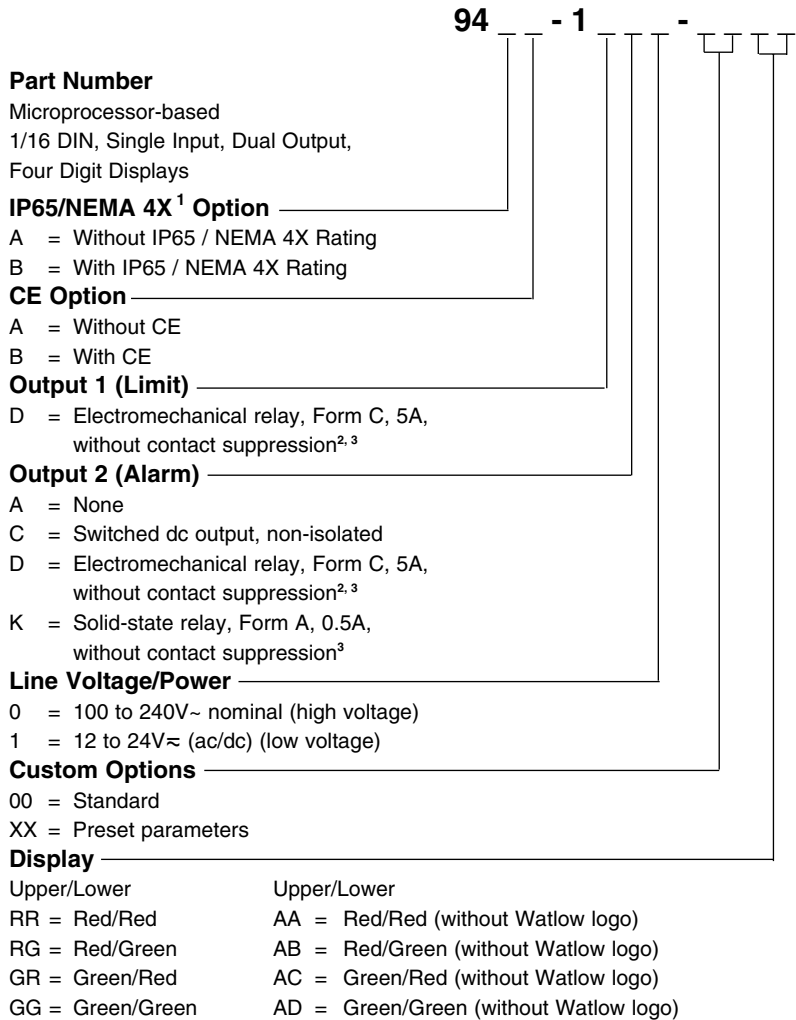

¹To effect IP65 (NEMA 4X) rating requires a minimum mounting panel thickness of 1.5 mm (0.06 inch) and surface finish not rougher than 812µ mm (0.32µ inch). Use Greenlee punch 60287.

²Electromechanical relays warranted for 100,000 closures only. Solid-state switching devices recommended for applications requiring fast cycle times or extended service life.

³Switching inductive loads (relay coils, etc.) requires using an RC suppressor. Quencharc from ITW PAKTRON is recommended, Watlow part number 0804-0147-0000.

NOTE: User documentation may be available in French, German, Spanish, Italian and Dutch, as well as English. Check Watlow's website (www.watlow.com/) for availability. Specify language at time of order.

Index

A

- ⊕ Advance key 3.1
- Alarm High 4.6
- Alarm Low 4.6
- alarms 5.1
 - clearing an alarm 5.1
 - latching 5.1
 - non-latching 5.1
 - process 5.1
 - silencing 5.1

B - C

- Bottom Display 4.4
- calibration A.3-A.5
 - restoring factory calibration A.4
 - RTD calibration procedure A.5
 - Thermocouple cal procedure A.5
- Calibration Menu A.4
- Calibration Offset 4.6
- CE Declaration of Conformity A.12
- Celsius-Fahrenheit 4.3
- clearing an alarm 5.1

D

- Declaration of Conformity A.12
- default parameters
 - Operation 4.6
 - Setup 4.3-4.5
- dimensions
 - faceplate 2.1
 - panel cutout 2.1
 - side view 2.1
- DIP Switches 4.1
- Display 3.1
- ⬇ Down-arrow key 3.1

E

- entering the Setup Menu 4.2
- error codes 5.2
- error code actions 5.2

F

- feedback inside front cover
- field calibration A.5

G

- general description 1.1
- Glossary A.7-A.8

H

- High Limit Set Point 4.6
- high voltage wiring 2.3
- Hysteresis - Alarm 4.4
- Hysteresis - Limit 4.4

I

- indicator lights 3.1
- Input
 - wiring 2.4
 - DIP Switch 4.1
 - parameter 4.3
 - ranges 4.5
 - RTD 2.4, 4.4
 - thermocouple 2.4
 - type 4.3, 4.5
- installation procedure 2.1-2.2

J - K

- Keys 3.1

L

- ladder wiring diagram 2.7
- Latching 4.4, 5.1
- Lock Parameter 4.3
- Low Limit Set Point 4.6
- low voltage wiring 2.3
- Lower Display 3.1, 4.4

M

- mechanical relay, 5 Amp
 - Output 1 Wiring 2.5
 - Output 2 Wiring 2.5
- Model Number A.10
- mounting collar 2.2
- mounting case 2.2

N

- NEMA 4X seal 2.1-2.2
- Noise
 - eliminating A.2
 - sources A.1
 - decreasing sensitivity A.1-A.2

O

- Operation Menu 4.6
- Operation Parameters 4.6
- Output 1 2.5-2.6, 4.4
- Output 2 2.5, 4.4
- Output Wiring
 - mechanical relay 2.5
 - switched dc 2.6
 - solid state relay 2.6
- overview of the Series 94 1.1

P

- power wiring 2.3
- process alarm 5.1

Q

- Quick Reference Sheet A.13-A.14

R

- Range High 4.3
- Range Low 4.3
- removing controller 2.2
- RESET key 3.1
- restoring calibration A.4
- returns back cover
- RTD 4.4
- RTD Calibration A.5
- RTD Sensor Wiring 2.4

S

- safety information inside front cover
- sensor installation 2.4
- setting up the Series 94 4.1
- Setup Menu 4.2, 4.5
- Setup Parameters 4.3-4.5
- Silencing 4.4
- Specifications A.9

T

- terminals A.9
- technical assistance inside front cover
- thermocouple calibration A.5
- thermocouple sensor wiring 2.4
- torque A.9

U - Z

- ⬆ Up-arrow key 3.1
- Upper Display 3.1, 4.4
- warranty back cover
- wiring 2.3
- wiring example 2.7

Declaration of Conformity

Series 94

WATLOW Winona Inc.

1241 Bundy Boulevard

Winona, Minnesota 55987 USA



Declares that the following product:

English

Designation: Series 94
Model Number(s): 9 4(A or B) (B) -1 D (A, C, D or K) (0 or 1) -(Any four letters or numbers)
Classification: Safety Component (Temperature Limit Controller), Installation Category II, Pollution Degree 2
Rated Voltage: 100 to 240V~ or 12 to 24V≈
Rated Frequency: 50/60 Hz
Rated Power Consumption: 7VA maximum (12 to 24V≈) or 12VA maximum

Meets the essential requirements of the following European Union Directives by using the relevant standards show below to indicate compliance.

89/336/EEC Electromagnetic Compatibility Directive

EN 61326:1997 With A1:1998 – Electrical equipment for measurement, control and laboratory use – EMC requirements (Industrial Immunity, Class A Emissions).

EN 61000-4-2:1996 With A1, 1998 – Electrostatic Discharge Immunity
EN 61000-4-3:1997 – Radiated Field Immunity
EN 61000-4-4:1995 – Electrical Fast-Transient / Burst Immunity
EN 61000-4-5:1995 With A1, 1996 – Surge Immunity
EN 61000-4-6:1996 – Conducted Immunity
EN 61000-4-11:1994 Voltage Dips, Short Interruptions and Voltage Variations Immunity
EN 61000-3-2:1995 With A1-3:1999 – Harmonic Current Emissions
EN 61000-3-3:1995 With A1:1998 – Voltage Fluctuations and Flicker

73/23/EEC Low-Voltage Directive

EN 61010-1:1993 With A1:1995 Safety Requirements of electrical equipment for measurement, control and laboratory use. Part 1: General requirements

Déclare que le produit suivant:

Français

Désignation: Série 94
Numéro(s) de modèle(s): 9 4 (A ou B) (B) - 1 D (A, C, D ou K) (0 ou 1) - (quatre chiffres ou lettres quelconques)
Classification: Composant de sécurité (limiteur de température), installation catégorie II, degré de pollution 2
Tension nominale: 100 à 240 V~ ou 24 à 28 V≈
Fréquence nominale: 50/60 Hz
Consommation d'alimentation nominale: 7 VA maximum (12 à 24 V≈) ou 12 VA maximum (100 à 240 V~)

Conforme aux exigences de la (ou des) directive(s) suivante(s) de l'Union Européenne figurant aux sections correspondantes des normes et documents associés ci-dessous :

89/336/EEC Directive de compatibilité électromagnétique

EN 50082-2: 1995 Norme générique d'insensibilité électromagnétique, Partie 2: Environnement industriel

EN 61000-4-2: 1995 Décharge électrostatique
EN 61000-4-4: 1995 Courants électriques transitoires rapides
EN 61000-4-3: 1994 Insensibilité à l'énergie rayonnée
EN 61000-4-6: 1994 Insensibilité à l'énergie par conduction
ENV 50204: 1995 Téléphone cellulaire
EN 50081-2: 1994 Norme générique sur les émissions électromagnétiques, Partie 2: Environnement industriel
EN 55011: 1991 Limites et méthodes de mesure des caractéristiques d'interférences du matériel radiofréquence industriel, scientifique et médical (Groupe 1, Classe A)
EN 61000-3-2: 1995 Limites d'émissions d'harmoniques
EN 61000-3-3: 1995 Limites de fluctuations et de vacillement du courant

73/23/EEC Directive liée aux basses tensions

EN 61010-1: 1993 Exigences de sécurité pour le matériel électrique de mesure, de commande et de laboratoire, Partie 1: Exigences générales

(2293)

Erklärt, daß das folgende Produkt:

Deutsch

Beschreibung: Serie 94
Modellnummer(n): 9 4(A oder B) (B) -1 D (A, C, D oder K) (0 oder 1) -(4 beliebige Buchstaben oder Ziffern)
Klassifikation: Sicherheitskomponente (Temperaturregelsystem), Installationskategorie II, Emissionsgrad 2
Nennspannung: 100 bis 240 V~ oder 12 bis 24 V≈
Nennfrequenz: 50/60 Hz
Nominaler Stromverbrauch: Max. 7 VA (12 bis 24 V≈) oder max. 12 VA (100 bis 240 V~)

Erfüllt die wichtigsten Normen der folgenden Anweisung(en) der Europäischen Union unter Verwendung des wichtigsten Abschnitts bzw. der wichtigsten Abschnitte die unten zur Befolgung aufgezeigt werden.

89/336/EEC Elektromagnetische Kompatibilitätsrichtlinie

EN 61326:1997 mit A1:1998 – Elektrisches Gerät für Messung, Kontrolle und Laborgebrauch – EMV-Anforderungen (Störfestigkeit Industriebereich, Klasse A Emissionen)

EN 61000-4-2:1996 mit A1, 1998 – Störfestigkeit gegen elektronische Entladung
EN 61000-4-3:1997 – Störfestigkeit gegen Strahlungsfelder
EN 61000-4-4:1995 – Störfestigkeit gegen schnelle Stöße/Burst
EN 61000-4-5:1995 mit A1, 1996 – Störfestigkeit gegen Überspannung
EN 61000-4-6:1996 – Geleitete Störfestigkeit
EN 61000-4-11:1994 Störfestigkeit gegen Spannungsabfall, kurze Unterbrechungen und Spannungsschwankungen
EN 61000-3-2:1995 mit A1-3:1999 – Harmonische Stromemissionen
EN 61000-3-3:1995 mit A1:1998 – Spannungsfluktuationen und Flimmern
EN 61000-3-3: 1995 Grenzen der Spannungsschwankungen und Flimmern

73/23/EEC Niederspannungsrichtlinie

EN 61010-1:1993 mit A1:1995 Sicherheitsanforderungen für elektrische Geräte für Messungen, Kontrolle und Laborgebrauch. Teil 1: Allgemeine Anforderungen

Declara que el producto siguiente:

Español

Designación: Serie 94
Números de modelo: 9 4 (A o B)(B) - 1 D(A, C, D o K)(0 ó 1) - (Cualquier combinación de cuatro números y letras)
Clasificación: Componente de seguridad (Controlador de límite de temperatura), categoría de instalación II, grado de contaminación ambiental 2
Tensión nominal: 100 a 240V~ o 12 a 24 V≈
Frecuencia nominal: 50/60 Hz
Consumo nominal de energía: 7 VA máximo (12 a 24 V≈) o 12 VA máximo (100 a 240 V~)

Cumple con los requisitos esenciales de las siguientes Directrices de la Unión Europea mediante el uso de las normas aplicables que se muestran a continuación para indicar su conformidad.

89/336/EEC Directriz de compatibilidad electromagnética

EN 61326:1997 CON A1:1998.– Equipo eléctrico para medición, control y uso en laboratorio – Requisitos EMC (Inmunidad industrial, Emisiones Clase A).

EN 61000-4-2:1996 con A1, 1998 – Inmunidad a descarga electrostática
EN 61000-4-3:1997 – Inmunidad a campo radiado
EN 61000-4-4:1995 – Inmunidad a incremento repentino/rápidas fluctuaciones eléctricas transitorias
EN 61000-4-5:1995 con A1, 1996 – Inmunidad a picos de voltaje o corriente
EN 61000-4-6:1996 – Inmunidad por conducción
EN 61000-4-11:1994 Inmunidad a caídas de voltaje, variaciones y pequeñas interrupciones de voltaje
EN 61000-3-2:1995 con A1-3:1999 – Emisiones de corriente armónica
EN 61000-3-3:1995 con A1:1998 – Fluctuaciones de voltaje y centelleo.

73/23/EEC Directriz de bajo voltaje

EN 61010-1:1993 con A1:1995 Requisitos de seguridad de equipo eléctrico para medición, control y uso en laboratorio. Parte 1: Requisitos generales

Jim Boigenzahn

Winona, Minnesota, USA

Name of Authorized Representative

Place of Issue

General Manager

August 2001

Title of Authorized Representative

Date of Issue

Signature of Authorized Representative

Series 94 Quick Reference

Keys and Displays

Upper Display: Can indicate actual temperature, alarm low, alarm high, limit low set point value, limit high set point value, operating parameter values or an open sensor. When powering up, the upper display will be blank for five seconds.
 • To set to blank: set **UP** to **no** in the Setup Menu.

Lower Display: Can indicate actual temperature, alarm low, alarm high, limit low set point value, limit high set point value, operating parameter values or an open sensor. When powering up, the lower display will be blank for five seconds.
 • To set to blank: set **bpE** to **no** in the Setup Menu.

Advance Key: Press to step through the Operation, Setup and Calibration Menus.

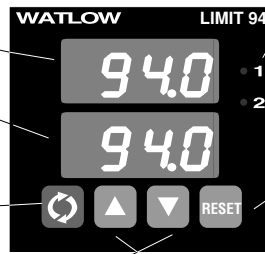

Output 1 Indicator Light: Lit when limit output is tripped.

Output 2 Indicator Light: Lit when alarm output is tripped.

RESET Key

- Press once to clear any limits or latched alarms.
- Press once to silence alarm output if silencing is enabled.
- Automatic reset on power loss.

- Up-arrow and Down-arrow Keys:** Increases or decreases the value of the displayed parameter.
- Press lightly to increase or decrease the value by one.
 - Press and hold down to increase or decrease the displayed value at a rapid rate. New data will self-enter in five seconds, or can be entered by pressing the Advance Key.
 - Press both simultaneously for three seconds to enter the Setup Menu. The **LDC** parameter appears.
 - Continue pressing both keys for three seconds to enter the Calibration Menu.

Alarms

The **process alarm** sets an absolute temperature. When the actual temperature exceeds that absolute temperature an alarm occurs. The process alarm set points may be independently set high and low. Under the Setup Menu, select the type of alarm output with the **OE2** Output 2 parameter. **PrA** sets a Process Alarm with alarm message displayed. **Pr** sets a Process alarm with no alarm message displayed.

Latching: Alarms can be latching or non-latching. When the alarm condition is removed a **non-latching alarm automatically** clears the alarm output. You must **manually clear a latching alarm** before it will disappear by pressing the Reset key.

To clear an alarm: First correct the alarm condition, then...

• **If the alarm is latching:**

Clear it manually by pressing the Reset key once as soon as the process temperature is inside the alarm limits and satisfies the alarm hysteresis **HSR**.

• **If the alarm is non-latching:**

The alarm clears itself automatically as soon as the process temperature is inside the alarm limits and satisfies the alarm hysteresis **HSR**.

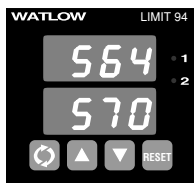

Press once to clear a latched and corrected alarm.

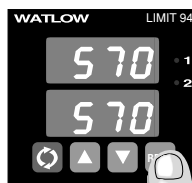

Flashing **LO** or **HI** in the lower display indicates an alarm when **OE2** is set to **PrA**. The lower display alternately shows information from the current parameter and the **LO** or **HI** alarm message at one second intervals. The alarm output is de-energized and the Output 2 indicator light is lit.

Alarm Silencing is available with the process alarm and has two uses:

When **SIL** is selected as "on," the controller automatically disables the alarm output on initial power up (in either the latching or non-latching mode). Alarm silencing disables the alarm output relay and the Output 2 indicator light. Once the process value crosses into the "safe" region, both a latching or a non-latching alarm is ready. Any future excursion outside of these alarm set points triggers an alarm.

When **SIL** is selected as "on," pressing the Reset Key will disable the alarm output relay and the indicator light once an alarm has occurred, but will not eliminate the alarm message if enabled. (If **OE2** is set to **PrA**.) This silences the alarm until the process returns to the "safe" region. Once within this region, the alarm is ready again. Any future excursion outside of the alarm set points triggers an alarm.

Errors

Three dashes **---** in the upper display indicate a Series 94 error. The error code is visible in the lower display.

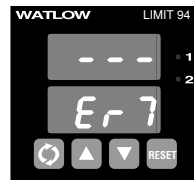

Er2 - Sensor underrange error (applies only to RTD units)

The sensor input generated a value lower than the allowable signal range, or the A/D circuitry malfunctioned. Enter a valid input. Make sure the **In** Input parameter (Setup Menu) and the DIP switch settings both match your sensor. Refer to the table below for the appropriate input type and range.

Er4 - Configuration error

The controller's microprocessor is faulty; call the factory.

Er5 - Non volatile checksum error

The nonvolatile memory checksum discovered a checksum error. Unless a momentary power interruption occurred while the controller was storing data, the nonvolatile memory is bad. Call the factory.

Er6 - A/D underflow error

The A/D circuit is underrange. An open or reversed polarity sensor is the most likely cause. Check the sensor; if the connection is good and functions properly, call the factory. The A/D underrange voltage is too low to convert an A/D signal. Make sure the **In** Input parameter (Setup Menu) matches your sensor and DIP switches are set accordingly.

Er7 - A/D overflow error

The A/D circuit is overrange. An open or reversed polarity sensor is the most likely cause. Check the sensor; if the connection is good, and the sensor functions properly, call the factory. The A/D overrange voltage is too high to convert an A/D signal. Make sure the **In** Input parameter (Setup Menu) matches your sensor and DIP switches are set accordingly.



Enter the Setup Menu by pressing the **▲**Up-arrow and **▼**Down-arrow keys simultaneously for three seconds. The lower display shows the **LOC** Lock parameter, and the upper display shows its current level. All keys are inactive until you release both keys. You can reach the **LOC** Lock parameter from anywhere. Use the **▶**Advance key to move through the menus and the **▲**Up-arrow and **▼**Down-arrow keys to select data. You will not see all parameters in this menu, depending on the controller's configuration and model number.

Setup Menu

Press **▲** and **▼** for 3 seconds

- LOC** Lock
- In** Input
- C.F** Celsius - Fahrenheit
- rL** Range Low
- rH** Range High
- DE1** Output 1
- HSL** Limit Hysteresis
- DE2** Output 2*
- HSA** Hysteresis Alarm*
- LAE** Latching*
- SIL** Silencing*
- rtd** RTD*
- UP** Upper Display
- bot** Bottom Display

* These parameters may be masked or hidden, depending on the settings of your controller. For an explanation of when the parameters will appear, refer to Setup Menu table to the right.

Note:

Do not enter any values here; make photocopies instead.

Operation Menu

- LLD** Low Limit Set Point*
- LHI** High Limit Set Point*
- ALD** Alarm Low*
- AHI** Alarm High*
- CAL** Calibration Offset

* These parameters may be masked or hidden, depending on the settings of your controller. For an explanation of when the parameters will appear, refer to the Operation Menu table to the right.

Setup Menu

Parameter	Value	Range	Factory Default	Appears If:
LOC		0 - 3	0	
In		D , H (K), E , n , S , b , rtd , rtd	D	DIP switch selectable.
C.F		C or F	F	LOC is set to 0
rL		rL to rH	Input dependent.	LOC is set to 0
rH		rH to rL	Input dependent.	LOC is set to 0
DE1		H , L , H.L	H.L	LOC is set to 0
HSL		1 - 9999, 0.1 - 999.9°F 1 to 5555, 0.1 to 555.5°C	3, 0.3°F 2, 0.2°C	LOC is set to 0
DE2		PrA = Process Alarm Pr = Process with no alarm message no = None	no	LOC is set to 0
HSA		1 - 9999, 0.1 - 999.9°F 1 - 5555, 0.1 - 555.5°C	3, 0.3°F 2, 0.2°C	DE2 is set to Pr or PrA and LOC is set to 0
LAE		LAE or nLA	nLA	DE2 is set to Pr or PrA and LOC is set to 0
SIL		On or OFF	OFF	DE2 is set to Pr or PrA and LOC is set to 0
rtd		DIS or d.in	d.in	In is set to rtd or rtd and LOC is set to 0
UP		no = no display shown Pro = Process LAL = Low limit set point HIL = High limit set point LAL = Alarm low set point HIL = Alarm high set point	Pro	LOC is set to 0
bot		no = no display shown Pro = Process LAL = Low limit set point HIL = High limit set point	H.L	LOC is set to 0

Operation Menu

Operation Parameters	Value	Range	Factory Default	Appears If
LLD		rL to LHI or rH if LHI is not active	rL	DE1 is set to H.L or L and LOC is not set to 3 .
LHI		LLD to rH or rL if LLD is not active	rH	DE1 is set to H.L or H and LOC is not set to 3 .
ALD		rL to AHI or rH if AHI is not active	rL	DE2 is set to PrA or Pr and LOC is set to 0 or I .
AHI		ALD to rH or rL if ALD is not active	rH	DE2 is set to PrA or Pr and LOC is set to 0 or I .
CAL		-180°F to 180°F/-100°C to 100°C; or -18.0°F to 18.0°F/-10.0°C to 10.0°C	0	LOC is set to 0 or I .



Watlow Winona

Watlow Winona is a division of Watlow Electric Manufacturing Company, St. Louis, Missouri, a manufacturer of industrial electric heating products, since 1922. Watlow begins with a full set of specifications and completes an industrial product that is manufactured totally in-house, in the U.S.A. Watlow products include electric heaters, sensors, controls and switching devices. The Winona operation has been designing solid state electronic control devices since 1962, and has earned the reputation as an excellent supplier to original equipment manufacturers. These OEMs depend upon Watlow Winona to provide compatibly engineered controls which they can incorporate into their products with confidence. Watlow Winona resides in a 100,000 square foot marketing, engineering and manufacturing facility in Winona, Minnesota.

How to Reach Us



Quality and Mission Statement:

Watlow Winona will be the world's best supplier of industrial temperature control products, services, and systems by exceeding our customers', employees', and shareholders' expectations.

Contact

Your Authorized Watlow Distributor is:

- or Phone: 507/454-5300.
- Fax: 507/452-4507.
- For technical support, ask for an Applications Engineer.
- To place an order, ask for Customer Service.
- To discuss a custom option, ask for a Series 93 Product Manager.

Warranty

The Watlow Series 94 is warranted to be free of defects in material and workmanship for 36 months after delivery to the first purchaser for use, providing that the units have not been misapplied. Since Watlow has no control over their use, and sometimes misuse, we cannot guarantee against failure. Watlow's obligations hereunder, at Watlow's option, are limited to replacement, repair or refund of purchase price, and parts which upon examination prove to be defective within the warranty period specified. This warranty does not apply to damage resulting from transportation, alteration, misuse, or abuse.

Returns

- Call or fax Customer Service for a Return Material Authorization (RMA) number before returning a controller.
- Put the RMA number on the shipping label, and also on a description of the problem.
- 20% of net price restocking charge applies to all standard units returned to stock.

Watlow Series 94 User's Manual

Watlow Winona, 1241 Bundy Blvd., P.O. Box 5580, Winona, MN 55987-5580, Phone: 507/454-5300, Fax: 507/452-4507